

Kabin Ölçüleri Schrankabmessungen

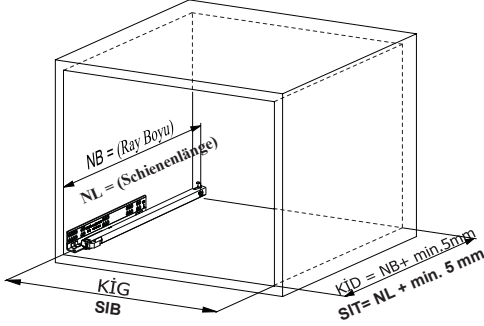

Kabin İç Geniřliđi	: KİG	Schrank-Innenbreite	: SİB
Kabin İç Derinliđi	: KİD	Schrank-Innentiefe	: SİT
Çekmece Derinliđi	: ÇD	Schublade-tiefe	: SLT
Çekmece İç Geniřliđi	: ÇİG	Schublade-Innenbreite	: SLİB
Nominal Boy (Ray boyu): NB		Nennlänge	: NL

Tavsiye Edilen Vida ve Şablonlar Empfohlene Schrauben und Schablonen

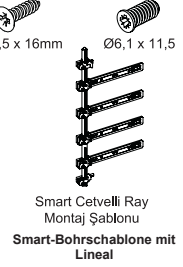
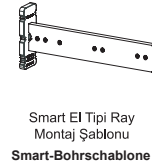
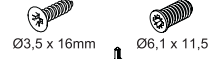

Smart-Bohrschablone mit Lineal

Rayların Vida Konum Ölçüleri Schraubenposition der Schienenführungen

Rayı, koyu renk ile işaretlenmiş deliklerden vidalayınız.
Schrauben Sie die Schiene an den markierten Löchern fest.

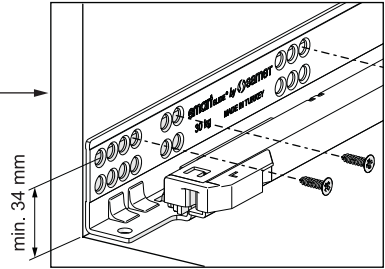
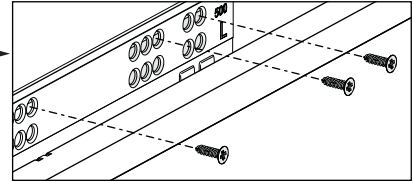
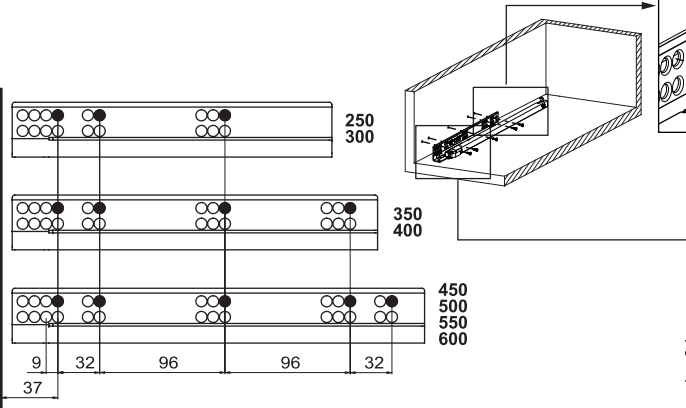

Çekmece Ölçüleri Schubladenabmessungen

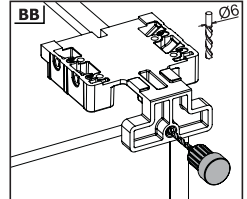
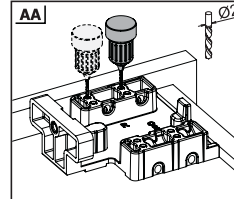
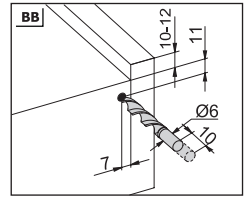
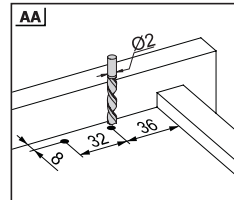
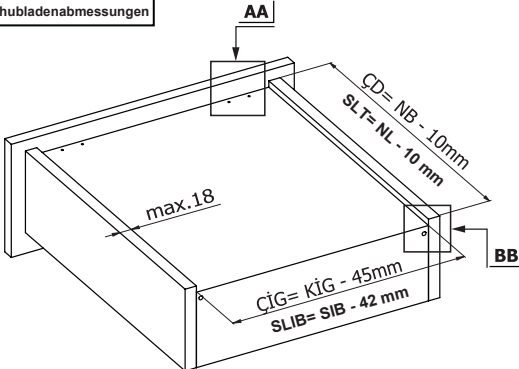

1

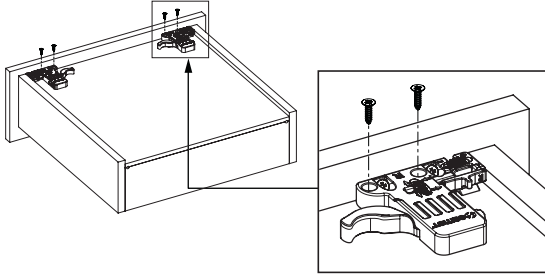

Not: Çekmece taban kalınlığı 12 mm'den küçük olduğunda, açılı mandal bağlama deliklerini kullanınız.

Hinweis: Verwenden Sie zur Montage von Smart Lock abgewinkelte Löcher, wenn die gewählte Holzbodenbreite weniger als 12 mm beträgt.

AA

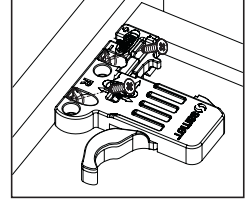
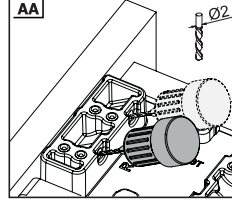

2

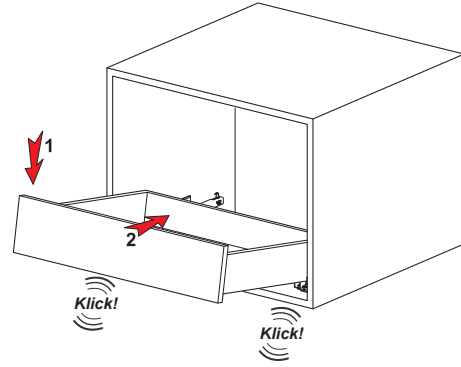

3

Somunu çevirerek, yukarıya doğru ayar yapabilirsiniz.
Die Aufwärtspositionierung lässt sich durch Drehen des Knopfes anpassen.

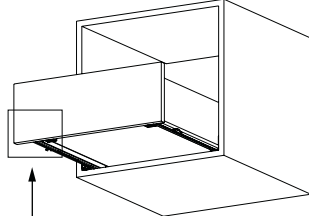
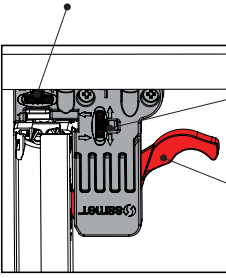

Somunu çevirerek, sağ-sol ayarını yapabilirsiniz.
Die Links-Rechts-Positionierung lässt sich durch Drehen des Knopfes anpassen.

Mandal kollarına aynı anda basarak, çekmeceyi kolayca yerinden çıkarabilirsiniz.
Sie können die Schublade leicht herausnehmen, indem Sie einfach den Drücker der Smart Lock-Arretierung betätigen.

Smart El Tipi Ray
Montaj Şablonu
Smart-Bohrschablone

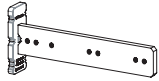

Kod / Code

12799902

12799904

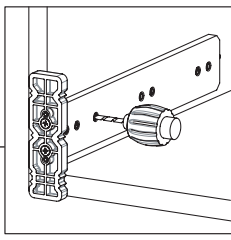
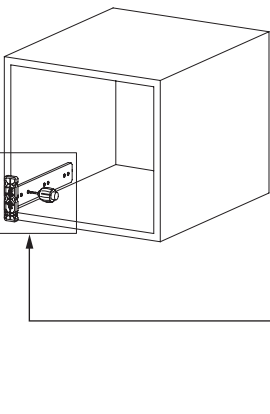

Smart Cetveli Ray
Montaj Şablonu
Smart-Bohrschablone mit Lineal

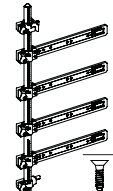

Kod / Code

12799901

12799905

