

**Kabin Ölçüleri**  
**Wymiary szafki**

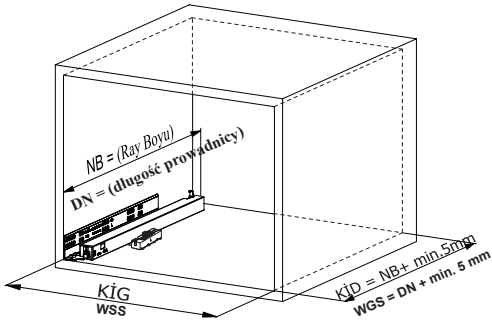

Kabin İç Genişliği	: KiG	Wewnętrzna szerokość szafki	: WSS
Kabin İç Derinliği	: KiD	Wewnętrzna głębokość szafki	: WGS
Çekmece Derinliği	: ÇD	Głębokość szuflady	: GS
Çekmece İç Genişliği	: ÇiG	Wewnętrzna szerokość szuflady	: WSSI
Nominal Boy (Ray boyu): NB		Długość nominalna	: DN

**Tavsiye Edilen Vida ve Şablonlar**  
**Zalecane wkręty i szablony**

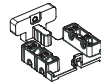
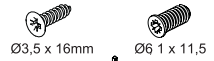

Smart Slide Mandal ve  
Tırnak Delme Şablonu  
Szablon Smart Lock

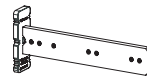

Smart EI Tipi Ray  
Montaj Şablonu  
Przyrząd Smart Drilling  
Jig



Smart Cevvelli Ray  
Montaj Şablonu  
Przyrząd Smart Drilling Jig  
z podziałką

**Rayların Vida Konum Ölçüleri**  
**Rozmieszczenie wkrętów dla prowadnicy**

Rayı, koyu renk ile işaretlenmiş deliklerden vidalayınız.  
Przykręć prowadnicę w zaznaczonych otworach.

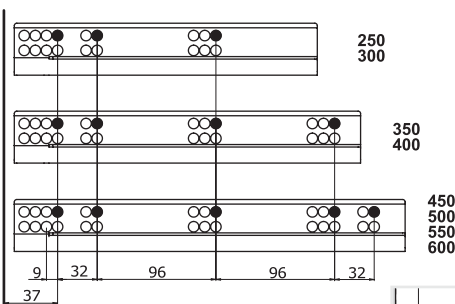

Bas - Aç Ayarı  
Regulacja mechanizmu Push-Open

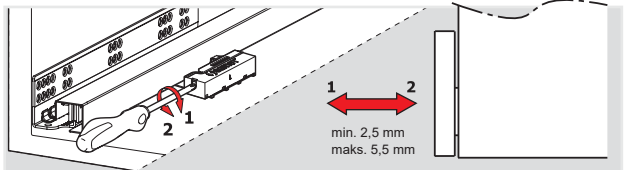
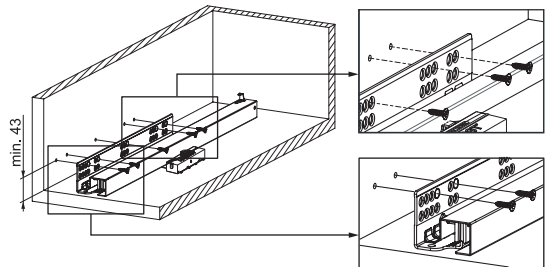

**Çekmece Ölçüleri**  
**Wymiary szuflady**

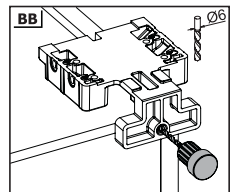
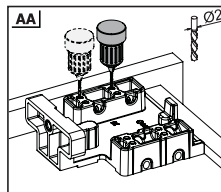
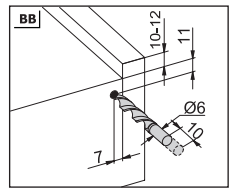
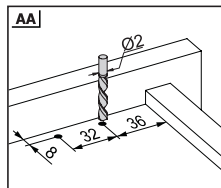
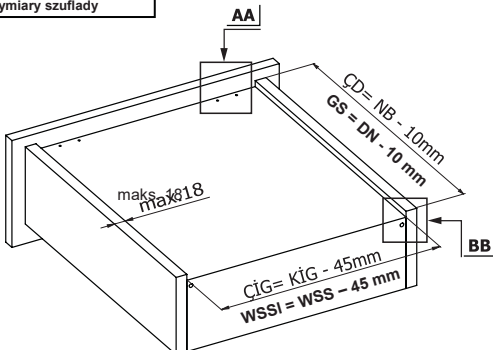

1

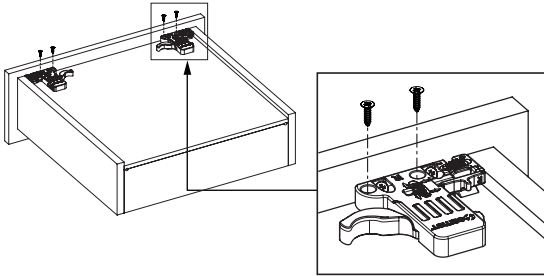

**Not:** Çekmece taban kalınlığı 12 mm'den küçük olduğunda, açılı mandal bağlama deliklerini kullanınız.

**Uwaga:** Jeśli szerokość drewnianego spodu jest mniejsza niż 12 mm, użyć otworów kątowych do montażu mechanizmu Smart Lock.

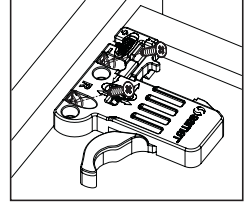
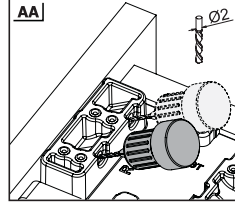

2

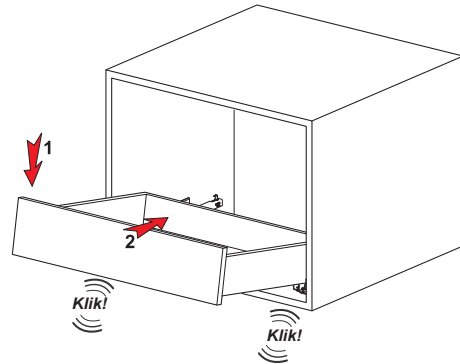

3

Somunu çevirerek, yukarıya doğru ayar yapabilirsiniz.  
Ustawienie w pionie można regulować za pomocą pokrętła.

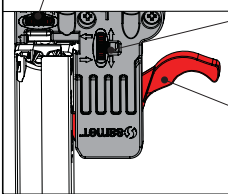
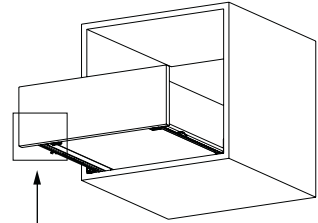

Somunu çevirerek, sağ-sol ayarını yapabilirsiniz.  
Ustawienie w kierunku lewo-prawo można regulować za pomocą pokrętła.

Mandal kollarına aynı anda basarak, çekmeceyi kolayca yerinden çıkarabilirsiniz.  
Aby wyciągnąć szufladę, wystarczy nacisnąć zatrzask Smart Lock

Smart El Tipi Ray  
Montaj Şablonu  
Przyrząd Smart Drilling Jig

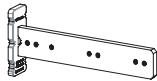

Kod / Kod

12799902

12799904

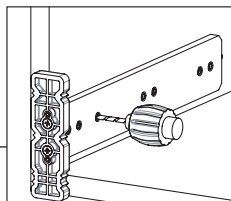
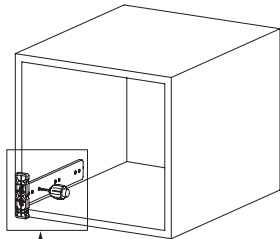

Smart Cetvelli Ray  
Montaj Şablonu  
Przyrząd Smart Drilling Jig z podziałką

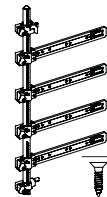

Kod / Kod

12799901

12799905

