

Kabin Ölçüleri
Dimensiones del armario

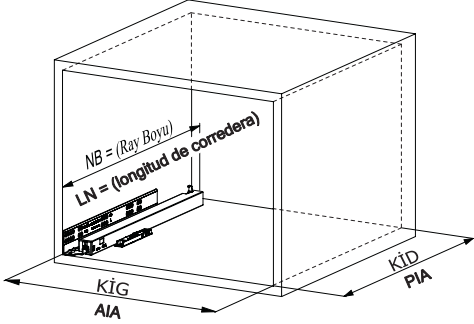

Kabin İç Geniřliđi	: KiG	Ancho interior del armario:	AIA
Kabin İç Derinliđi	: KiD	Profundidad interior del armario:	PIA
Çekmece Derinliđi	: ÇD	Profundidad del cajón:	PC
Çekmece İç Geniřliđi	: ÇiG	Ancho interior del cajón:	AIC
Nominal Boy (Ray boyu):	NB	Longitud nominal:	LN

Tavsiye Edilen Vida ve Şablonlar
Plantillas y tornillos recomendados

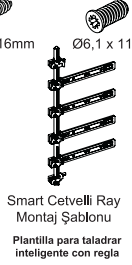

Rayların Vida Konum Ölçüleri

Ubicación de los tornillos para las correderas

Rayı, koyu renk ile işaretlenmiş deliklerden vidalayınız.

Atornille la corredera en los agujeros marcados.

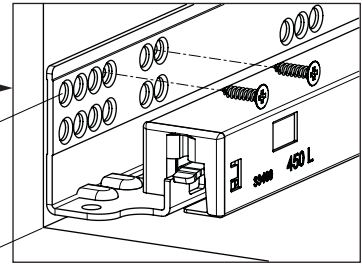
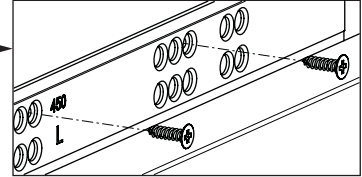
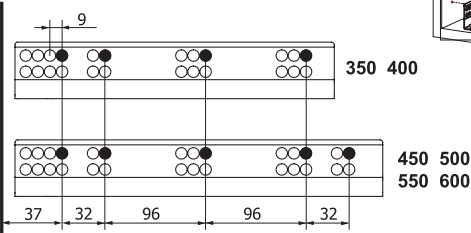

Çekmece Ölçüleri
Dimensiones del cajón

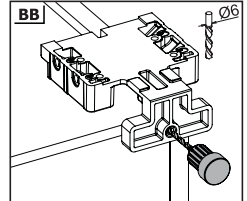
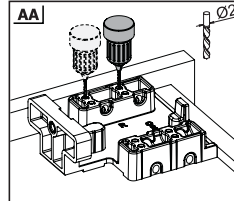
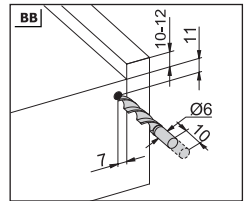
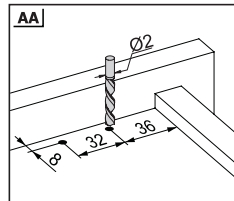
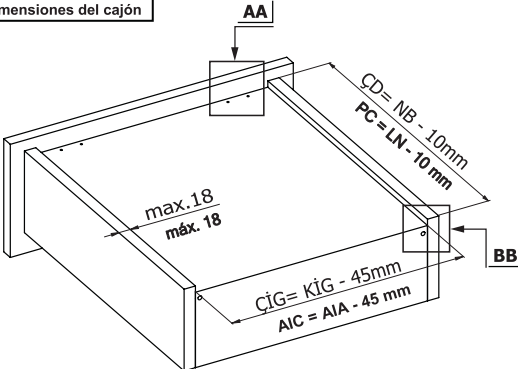

1

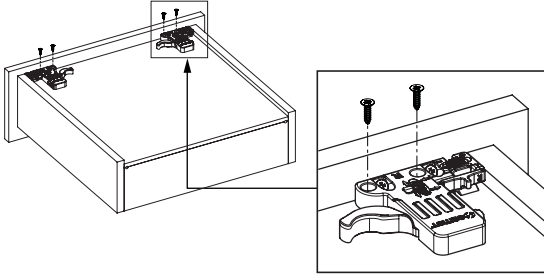

Not: Çekmece taban kalınlığı 12 mm'den küçük olduğunda, açılı mandal bağlama deliklerini kullanınız.

Nota: Utilice orificios en ángulo para montar la cerradura inteligente cuando el ancho del suelo de madera se seleccione inferior a 12 mm.

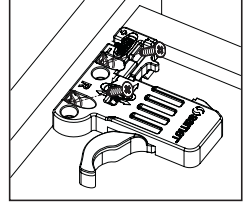
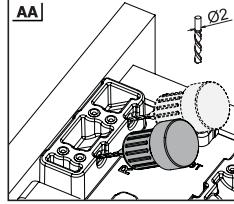

2

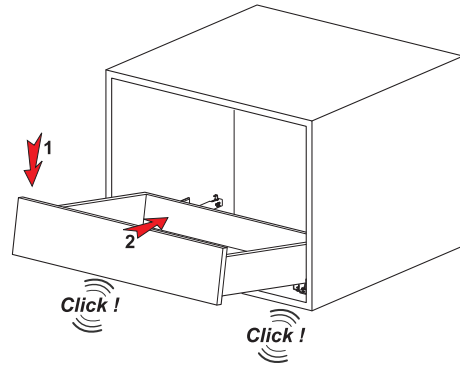

3

Somunu çevirerek, yukarıya doğru ayar yapabilirsiniz.
Puede ajustar la posición hacia arriba girando la perilla.

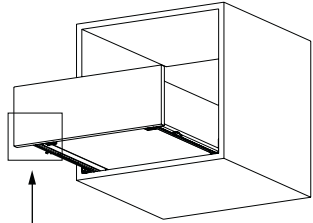
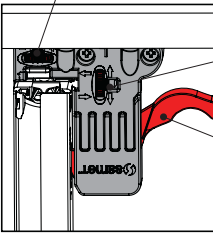

Somunu çevirerek, sağ-sol ayarını yapabilirsiniz.
Puede ajustar la posición de izquierda a derecha girando la perilla.

Mandal kollarına aynı anda basarak, çekmeceyi kolayca yerinden çıkarabilirsiniz.
Puede sacar fácilmente el cajón solo empujando el pestillo de la cerradura inteligente.

Smart El Tipi Ray
Montaj Şablonu
Plantilla para taladros inteligente

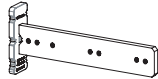

Kod / Código

12799902

12799904

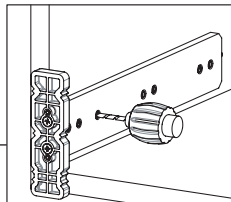
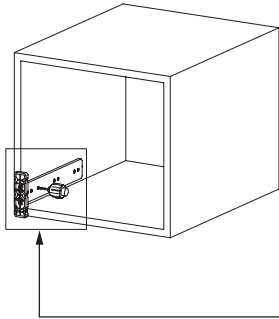

Smart Cetveli Ray
Montaj Şablonu
Plantilla para taladros inteligente con regla

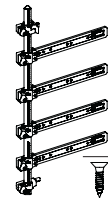

Kod / Código

12799901

12799905

