

Kabin Ölçüleri
Dimensioni armadio

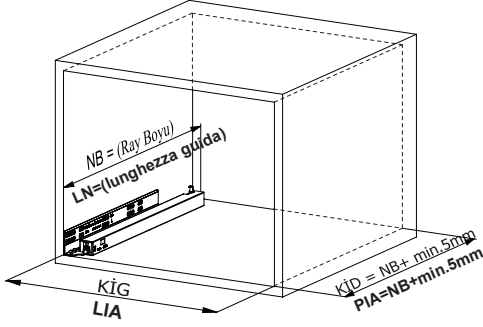

Kabin İç Genişliği	: KİG	Larghezza Interna Armadio	: LIA
Kabin İç Derinliği	: KİD	Profondità Interna Armadio	: PIA
Çekmece Derinliği	: ÇD	Profondità Cassetto	: PC
Çekmece İç Genişliği	: ÇİG	Larghezza Interna Cassetto	: LIC
Nominal Boy (Ray boyu)	: NB	Lunghezza Nominale	: LN

Tavsiye Edilen Vida ve Sablonlar
Viti e modelli raccomandati

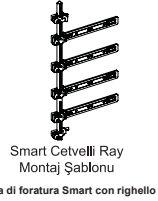
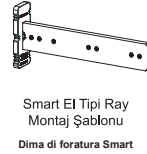

Rayların Vida Konum Ölçüleri
Posizione della vite per le guide

Rayı, koyu renk ile işaretlenmiş deliklerden vidalayınız.
Avvitare la guida a partire dai fori contrassegnati.

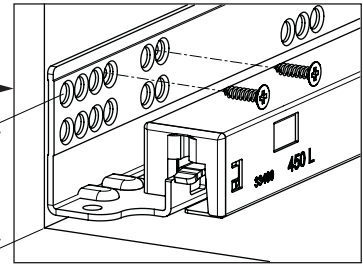
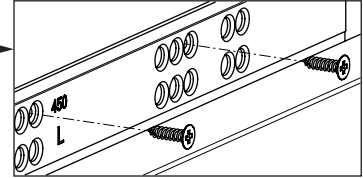
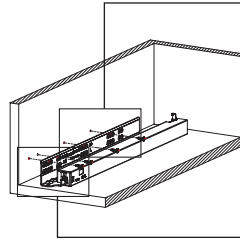
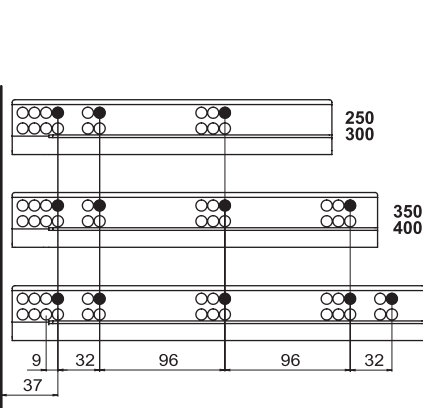

Çekmece Ölçüleri
Dimensioni del cassetto

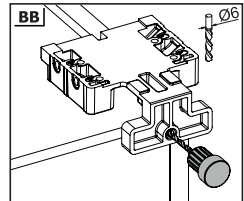
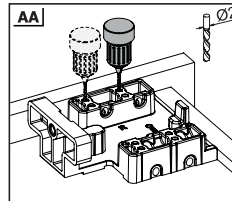
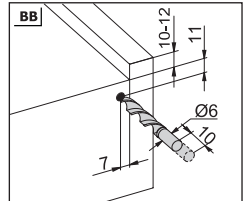
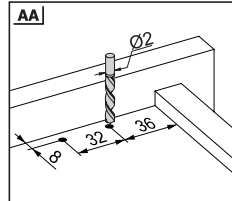
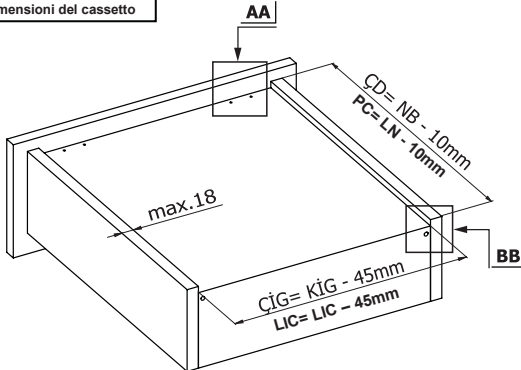

1

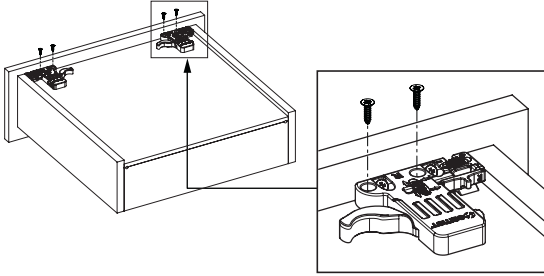

Not: Çekmece taban kalınlığı 12 mm'den küçük olduğunda, açılı mandal bağlama deliklerini kullanınız.

Nota: Utilizzare fori angolari per montare lo Smart lock quando la larghezza del fondo in legno è minore di 12 mm.

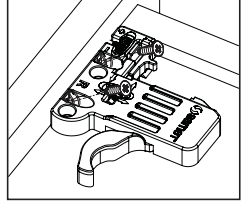
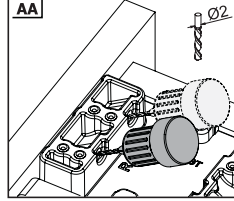

2

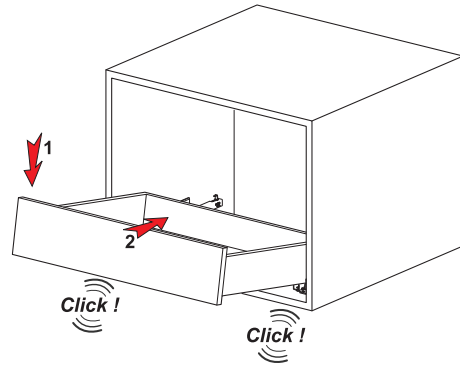

3

Somunu çevirerek, yukarıya doğru ayar yapabilirsiniz.

È possibile adattare il posizionamento superiore ruotando la manopola.

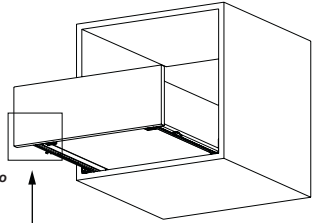
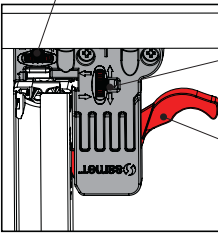

Somunu çevirerek, sağ-sol ayarını yapabilirsiniz.

È possibile adattare il posizionamento verso destra - sinistra ruotando la manopola.

Mandal kollarına aynı anda basarak, çekmeceyi kolayca yerinden çıkarabilirsiniz.

È possibile estrarre facilmente il cassetto spingendo il chiavistello dello Smart lock

Smart El Tipi Ray
Montaj Şablonu
Dima di foratura Smart

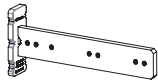

Kod / Codice

12799902

12799904

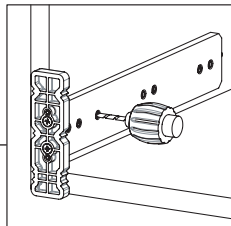
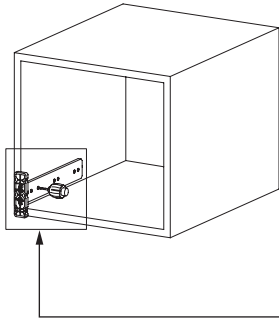

Smart Cetveli Ray
Montaj Şablonu
Dima di foratura Smart con righello

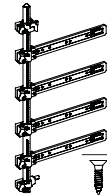

Kod / Codice

12799901

12799905

