

ULTIMADESINGLE

Undermount Slide Systems



Ultimade Single Wooden Drawer Slide

ULTIMADE SINGLE Drawer Systems, which enable custom design applications, offers excellent mobility and exceed expectations for lightweight solutions. This single extension drawer slide is ideal for minor storage needs. ULTIMADE SINGLE's integrated adaptive oil braking system adds elegance to the soft closing action.

Adaptive Braking Mechanism

The new integrated soft close system ensures gentle and quiet closing. Thanks to adaptive soft close technology, drawers can be closed softly with same smooth closing effect even if you change the load inside the drawer.



SmartLock Locking System

The SmartLock locking system provides easy mounting and safety, as well as tool-free adjustment ensures precise finishing touches.

Drawer and Cabinet Dimensions S-C [Lock-Fix]

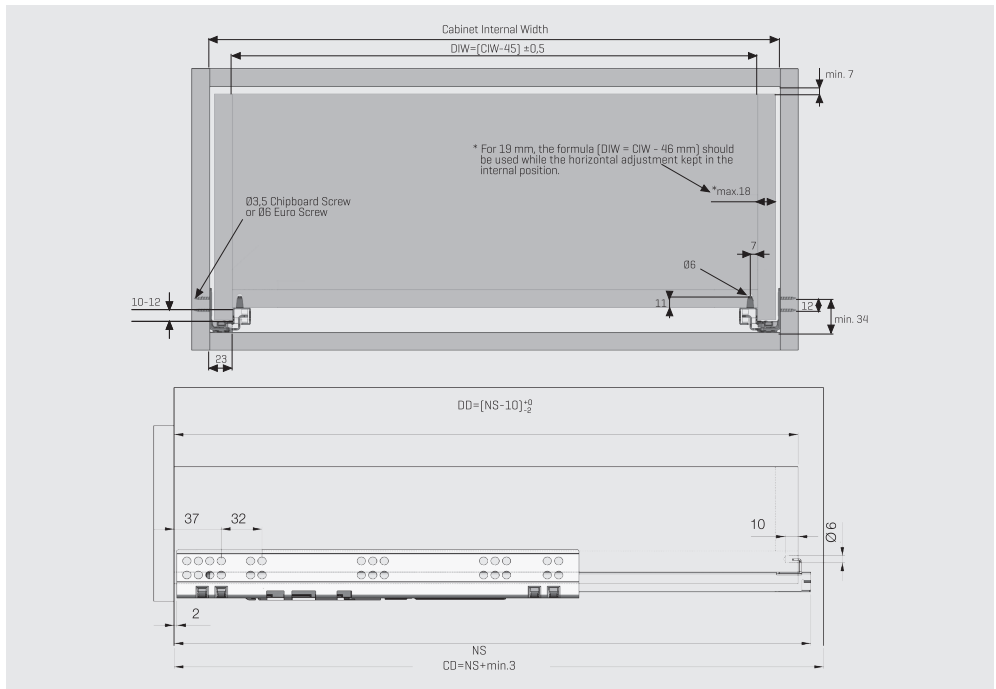

CD Cabinet Depth
CIW Cabinet Internal Width
NS Nominal Size
DIW Drawer Internal Width
DD Drawer Depth

* All dimensions in the diagram are in mm

Recommended Screws for Slide Assembly

Ø3,5x16 mm Chipboard Screw



Ø6,1x11,5 mm Euro Screw



Single Extension Lock-Fix

Ultimade Single Drawer Slide Right-Left		
NOMINAL SIZE	CODE With Soft-Close	RETAIL PACKAGE
350 mm	12722230384	6 Set
400 mm	12722230484	6 Set
450 mm	12722230584	6 Set
500 mm	12722230684	6 Set

SmartLock® Right-Left		
CODE Right	CODE Left	PACKING
12790773	12790774	120 Pcs

Lock-Fix Drilling Holes

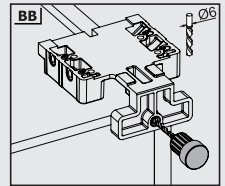
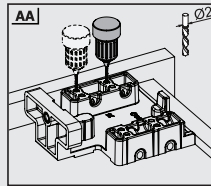
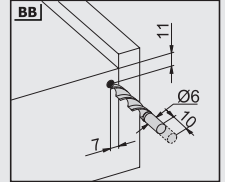
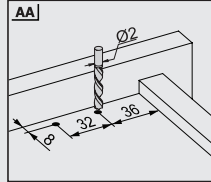
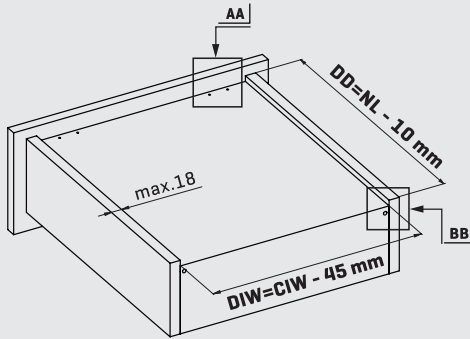

Screw Location for the Slides

Screw the slide from marked holes.

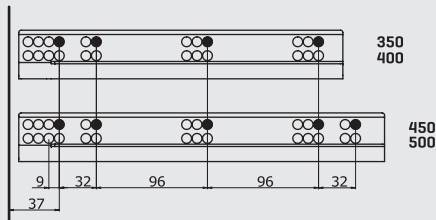

www.greenplysamet.com

- Greenply-Samet
- GreenplySamet
- GreenplySamet
- GreenplySamet
- GreenplySamet