

Kabin Ölçüleri
Wymiary szafki

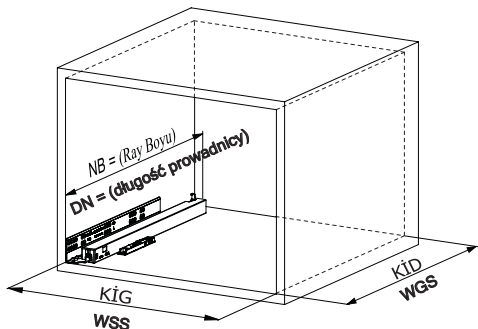

Kabin İç Genişliği	: KİG	Wewnętrzna szerokość szafki:	WSS
Kabin İç Derinliği	: KİD	Wewnętrzna głębokość szafki:	WGS
Çekmece Derinliği	: ÇD	Głębokość szuflady:	GS
Çekmece İç Genişliği	: ÇİG	Wewnętrzna szerokość szuflady:	WSSI
Nominal Boy (Ray boyu):	NB	Długość nominalna:	DN

Tavsiye Edilen Vida ve Şablonlar
Zalecane wkręty i szablony

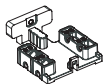

Smart Slide Mandal ve
Tirmak Delği Delme Şablonu

Şablon Smart Lock

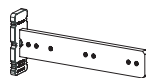

Smart EI Tipi Ray
Montaj Şablonu
Przyrząd Smart
Drilling Jig

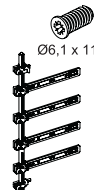

Smart Cetvelli Ray
Montaj Şablonu
Przyrząd Smart Drilling
Jig z podziałką

Rayların Vida Konum Ölçüleri
Rozmieszczenie wkrętów dla
prowadnicy

Rayı, koyu renk ile işaretlenmiş deliklerden vidalayınız.
Przykręcić prowadnicę wznaczonych otworach.

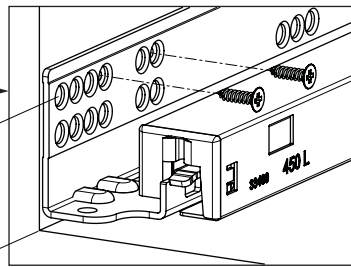
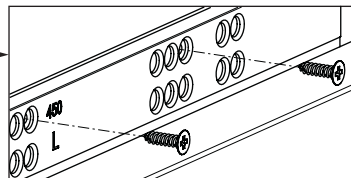
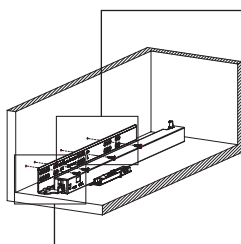
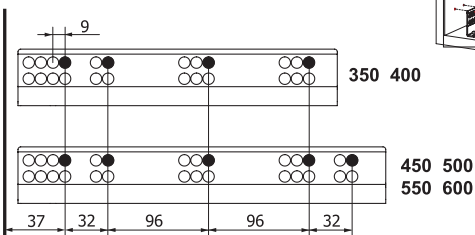

Çekmece Ölçüleri
Wymiary szuflady

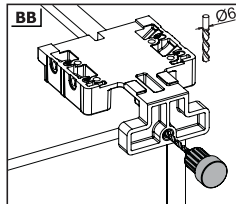
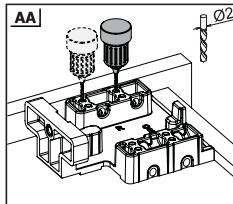
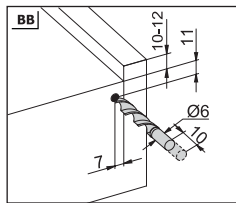
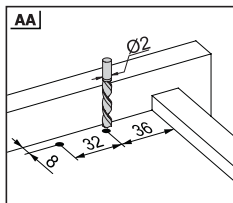
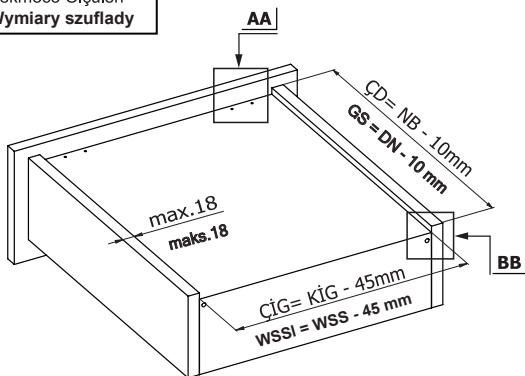

1

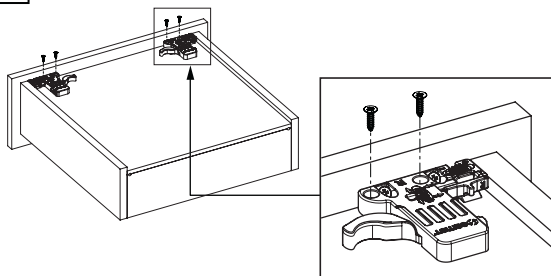

Not: Çekmece taban kalınlığı 12 mm'den küçük olduğunda, açılı mandal bağlama deliklerini kullanınız.

Uwaga: Jeśli szerokość drewnianego spodu jest mniejsza niż 12 mm, użyć otworów kątowych do montażu mechanizmu Smart Lock.

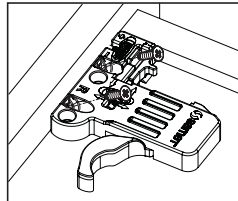
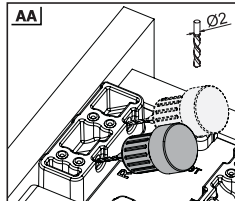

2

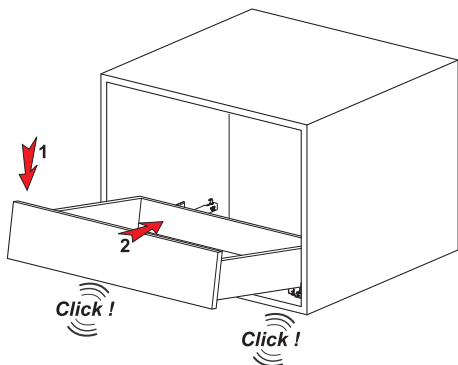

3

Somunu çevirerek, yukarıya doğru ayar yapabilirsiniz.
Ustawienie w pionie można regulować za pomocą pokrętła.

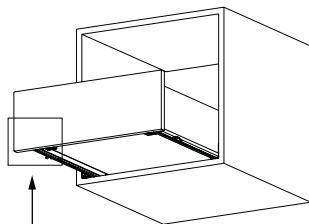
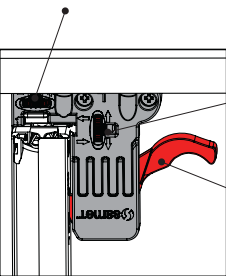

Somunu çevirerek, sağ-sol ayarını yapabilirsiniz.
Ustawienie w kierunku lewo-prawo można regulować za pomocą pokrętła.

Mandal kollarına aynı anda basarak, çekmeceyi kolayca yerinden çıkarabilirsiniz.
Aby wyciągnąć szufladę, wystarczy nacisnąć zatrzask Smart Lock

Smart El Tipi Ray
Montaj Şablonu
Przyrząd Smart
Drilling Jig

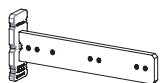

Kod / Kod

12799902

12799904

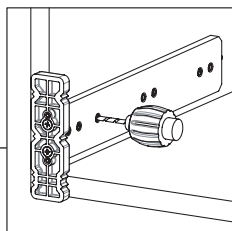
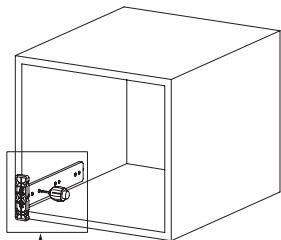

Smart Cetvelli Ray
Montaj Şablonu
Przyrząd Smart Drilling Jig
z podziałką

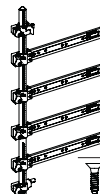

Kod / Kod

12799901

12799905

