

Kabin Ölçüleri
Dimensions du meuble

Kabin İç Genişliği	: KİG	Largeur intérieure du meuble	: LIM
Kabin İç Derinliği	: KİD	Profondeur intérieure du meuble	: PİM
Çekmece Derinliği	: ÇD	Profondeur du tiroir	: PT
Çekmece İç Genişliği	: ÇİG	Largeur intérieure du tiroir	: LİT
Nominal Boy (Ray boyu)	: NB	Longueur nominale	: LN

Tavsiye Edilen Vida ve Şablonlar
Vis et modèles recommandésSmart Slide Mandal ve
Tırnak Deliği Delme ŞablonuModelé Smart
LockSmart El Tipi Ray
Montaj ŞablonuGabarit de forage
intelligentSmart Cetveli Ray
Montaj ŞablonuGabarit de forage
intelligent avec règleRayların Vida Konum Ölçüleri
Emplacement des vis des coulissesRayı, koyu renk ile işaretlenmiş deliklerden vidalayınız.
Vissez la coulisse dans les trous correspondants.Çekmece Ölçüleri
Dimensions du tiroir

1

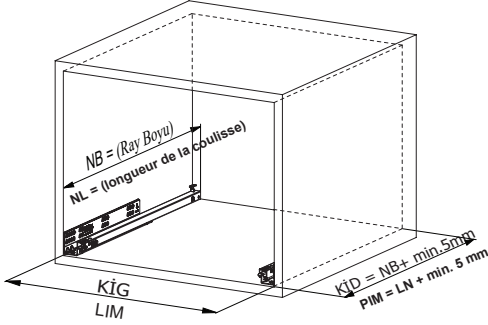
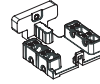
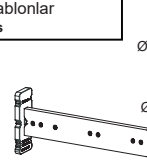
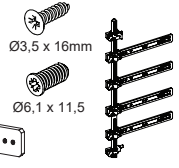
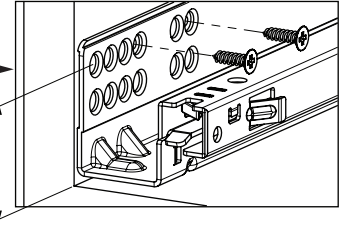
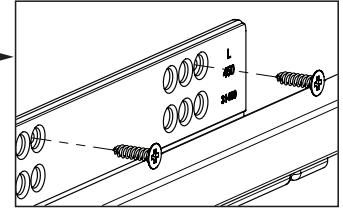
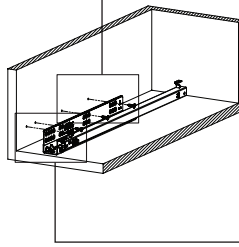
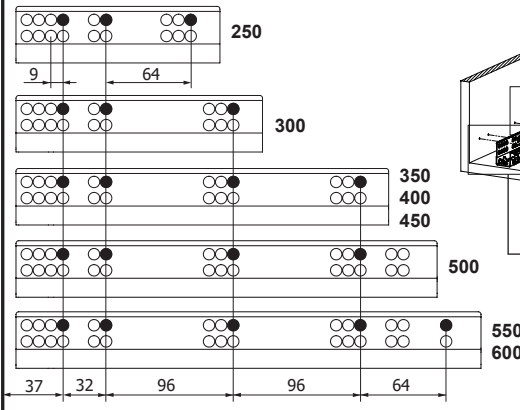
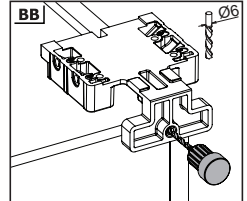
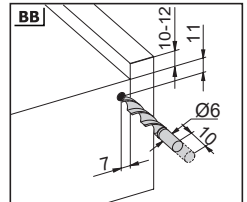
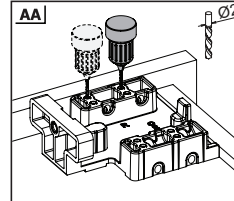
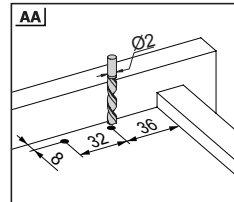
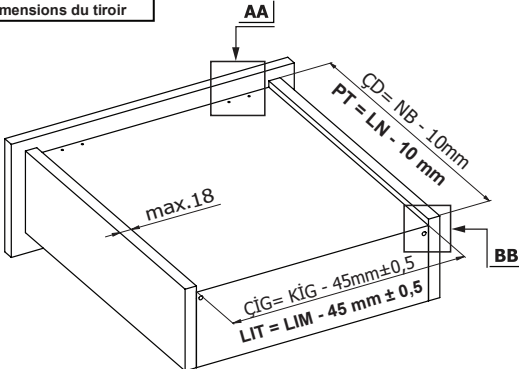
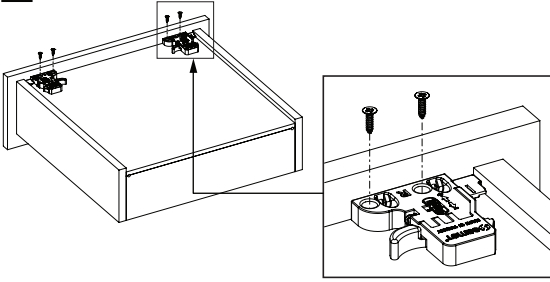

Not: Çekmece taban kalınlığı 12 mm'den küçük olduğunda, açılı mandal bağlama deliklerini kullanınız.

Remarque : Utilisez les trous obliques pour monter la serrure intelligente si la largeur de la planche de bois est inférieure à 12 mm.

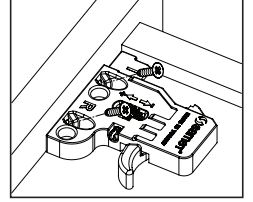
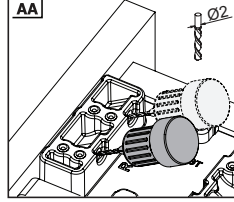

2

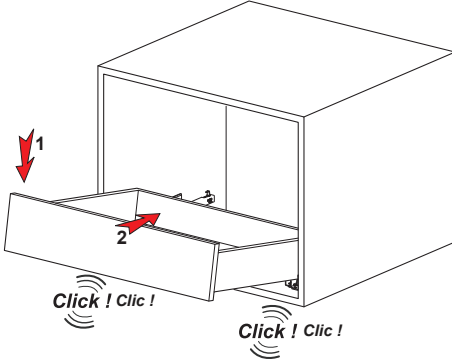

3

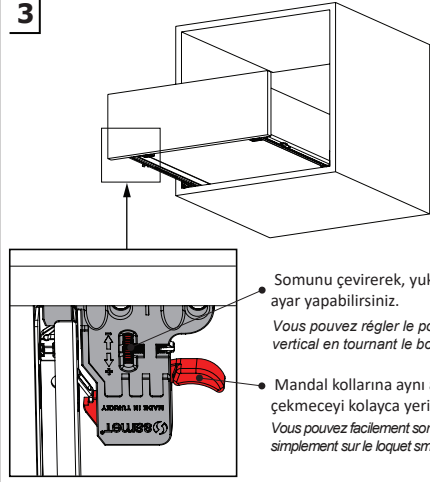

Somunu çevirerek, yukarıya doğru ayar yapabilirsiniz.

Vous pouvez régler le positionnement vertical en tournant le bouton.

Mandal kollarına aynı anda basarak, çekmeceyi kolayca yerinden çıkarabilirsiniz.

Vous pouvez facilement sortir le tiroir en appuyant simplement sur le loquet smart lock.

Smart El Tipi Ray
Montaj Şablonu

Gabarit de forage intelligent

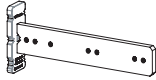

Kod / Code

12799902

12799904

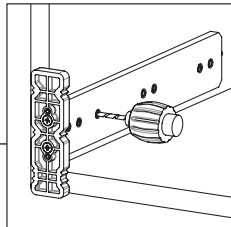
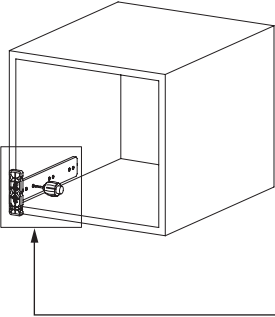

Smart Cetveli Ray
Montaj Şablonu

Gabarit de forage intelligent avec règle

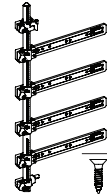

Kod / Code

12799901

12799905

