

**Kabin Ölçüleri**  
**Wymiary szafki**

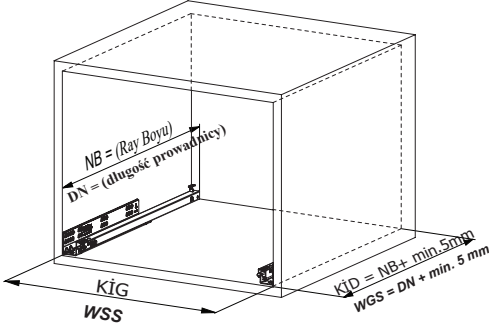

Kabin İç Geniřliđi	: KİG	Wewnętrzna szerokořć szafki	: WSS
Kabin İç Derinliđi	: KİD	Wewnętrzna gębokoořć szafki	: WGS
Çekmece Derinliđi	: ÇD	Gębokoořć szuflady	: GS
Çekmece İç Geniřliđi	: ÇİG	Wewnętrzna szerokořć szuflady	: WSSI
Nominal Boy (Ray boyu): NB		Długořć nominalna	: DN

**Tavsiye Edilen Vida ve řablonlar**  
**Zalecane wkręty i szablony:**

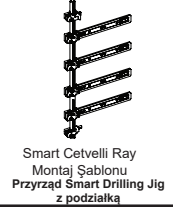
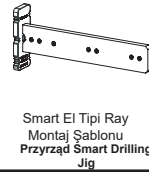
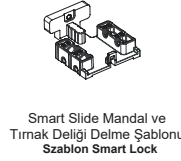

**Rayların Vida Konum Ölçüleri**  
**Rozmieszczenie wkrętów dla prowadnicy**

Rayı, koyu renk ile işaretlenmiş deliklerden vidalayınız.  
 Przykręćć prowadnicę w zaznaczonych otworach.

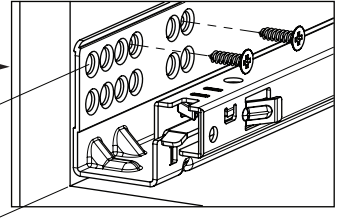
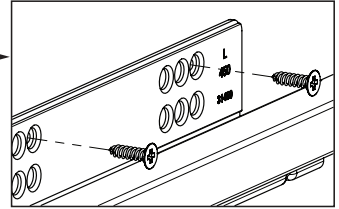
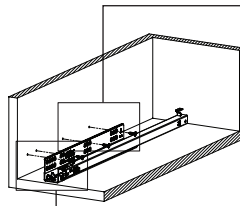
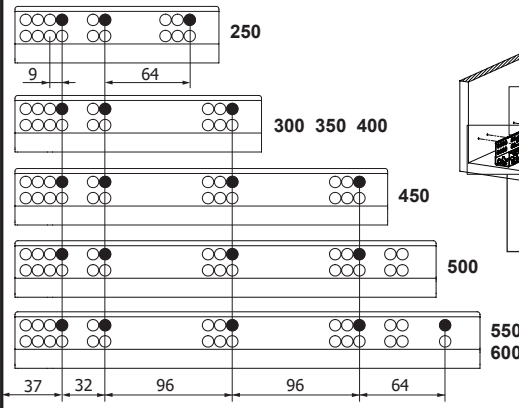

**Çekmece Ölçüleri**  
**Wymiary szuflady**

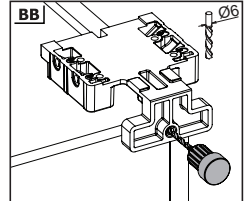
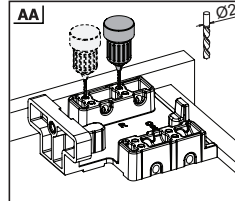
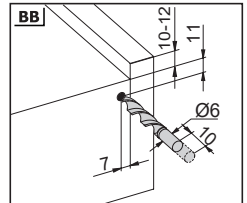
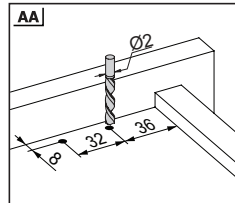
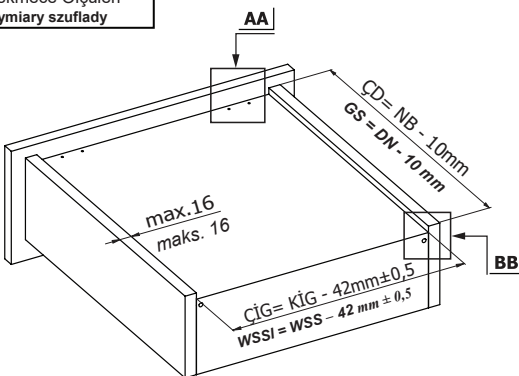

1

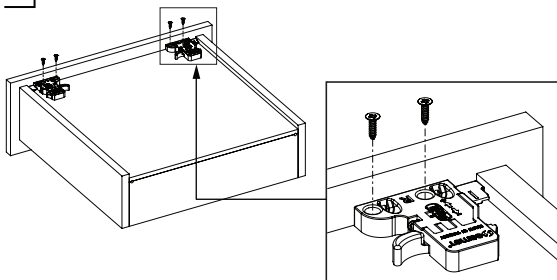

**Not:** Çekmece taban kalınlığı 12 mm'den küçük olduğunda, açılı mandal bağlama deliklerini kullanınız.

**Uwaga:** Jeśli szerokość drewnianego spodu jest mniejsza niż 12 mm, użyć otworów kątowych do montażu mechanizmu Smart Lock.

AA

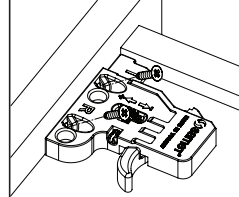
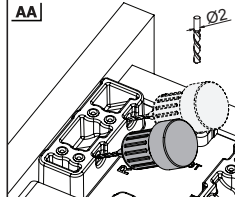

2

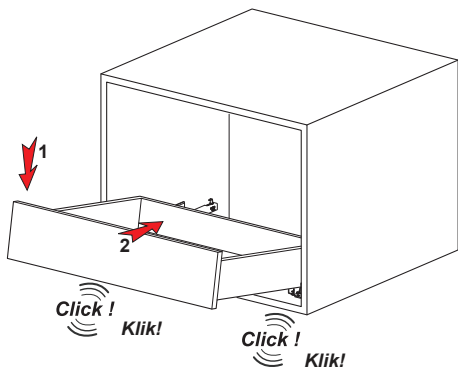

3

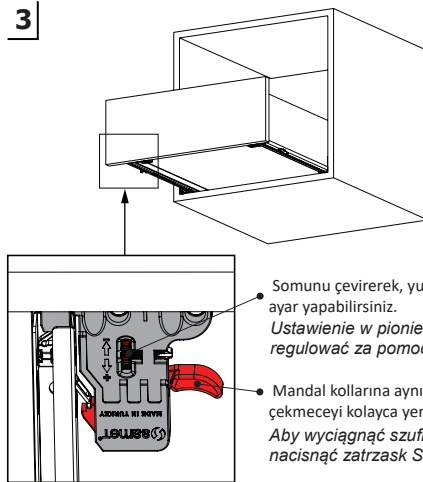

Somunu çevirerek, yukarıya doğru ayar yapabilirsiniz.  
Ustawienie w pionie można regulować za pomocą pokrętła.

Mandal kollarına aynı anda basarak, çekmeceyi kolayca yerinden çıkarabilirsiniz.  
Aby wyciągnąć szufladę, wystarczy nacisnąć zatrzask Smart Lock

Smart El Tipi Ray  
Montaj Şablonu  
Przyrząd Smart Drilling Jig

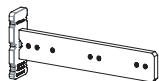

Kod / Kod

12799902

12799904

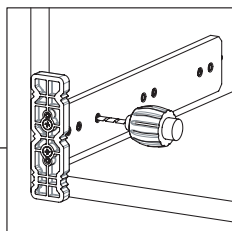
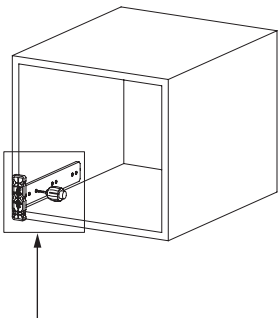

Smart Cetveli Ray  
Montaj Şablonu  
Przyrząd Smart Drilling Jig z podziałką

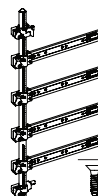

Kod / Kod

12799901

12799905

