

SO CLASS

Teleskopik Ray Sistemleri



samet



MUTFAK & BANYO

- Akışkanlığı yüksek hareket kabiliyeti ◀
- 45 kg'a kadar dinamik yük taşıma kapasitesi ◀
- Gelişmiş fren teknolojisi ◀
- Yüksek kaplama kalitesi ◀

OFİS ALANLARI

- ▶ Akışkanlığı yüksek hareket kabiliyeti
- ▶ Ofislere özel 700 mm'ye kadar çekmece boyları
- ▶ Gelişmiş fren teknolojisi
- ▶ Uzun çalışma ömrü



YAŐAM ALANLARI

- Akışkanlığı yüksek hareket kabiliyeti ◀
- Sađlam ve güçlü yapı ◀
- 27 mm mandallı ve vidalı versiyonlar ◀
- Hataları minimize eden yüksek tolerans deđerleri ◀





TEKNİK ÖZELLİKLER

- ▶ Yüksek kaliteli bilyeler/profiller ile sağlam ve güçlü yapı
- ▶ Akışkanlığı yüksek hareket kabiliyeti
- ▶ Gelişmiş fren teknolojisi
- ▶ Hataları minimize eden yüksek tolerans değerleri
 - 185 – 700 mm değişken çekmece boylarına uyumluluk
 - 10 – 45 kg arası yük taşıma kapasitesi
 - Vidalı [17, 27 mm] ve mandallı [27, 35, 43, 46 mm] montaj şekilleri
 - Mat, parlak ve siyah yüzey opsiyonları

SO CLASS

Teleskopik Ray Sistemleri

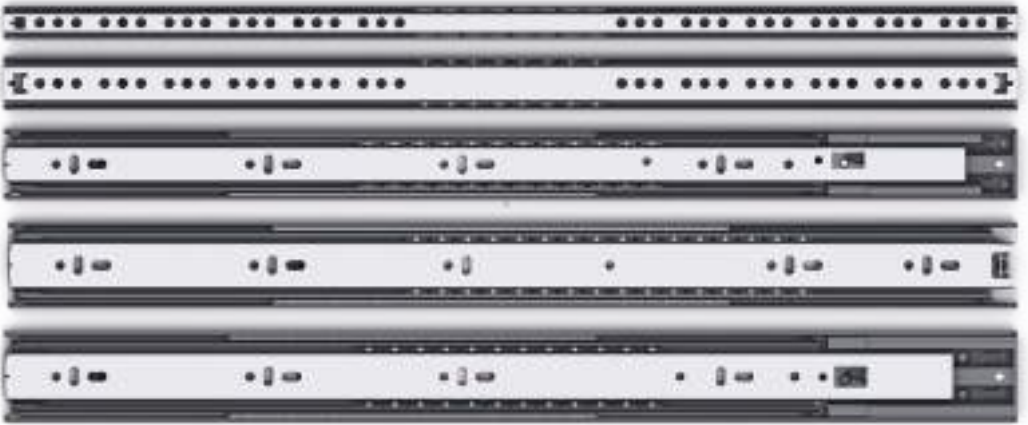

TAM AÇILIM RAY MONTAJ

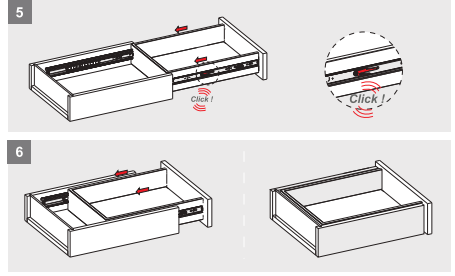
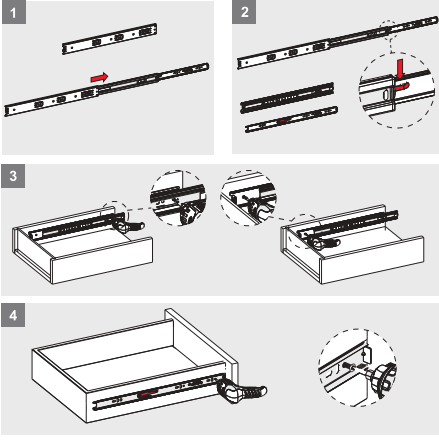

KİSMİ AÇILIM RAY MONTAJ

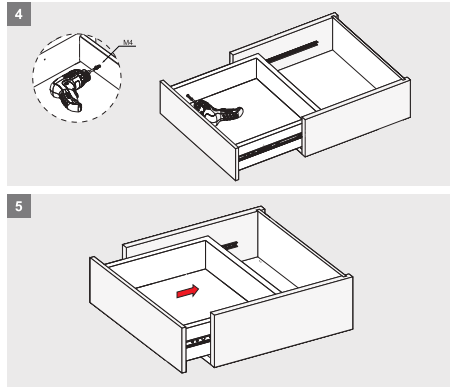
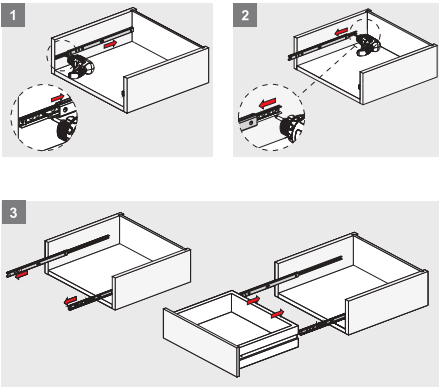

KİSMİ AÇILIM MANDALLI RAY MONTAJ

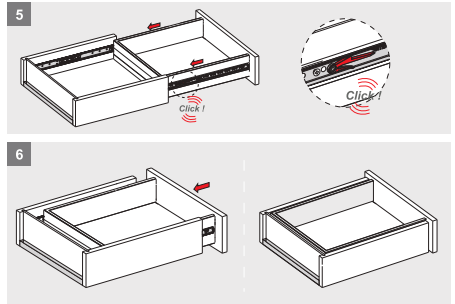
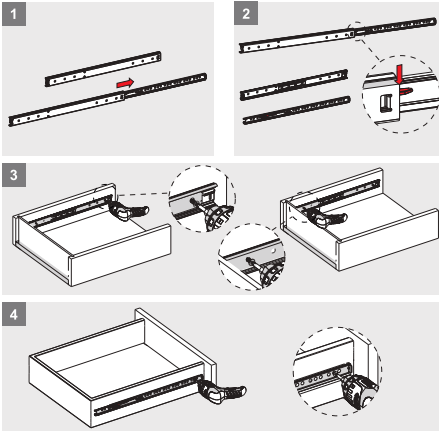

Kabin Ölçüleri

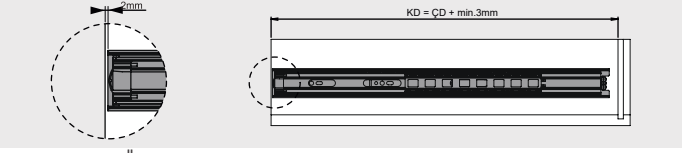

Çekmece Ölçüleri

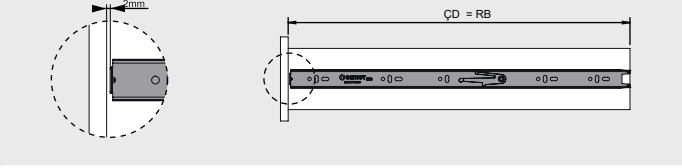

KİG : Kabin İç Genişliği
ÇG : Çekmece Genişliği

KD : Kabin Derinliği
ÇD : Çekmece Derinliği

RB : Ray Uzunluğu

Teknik Ölçüler

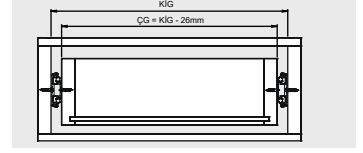

Parçalar

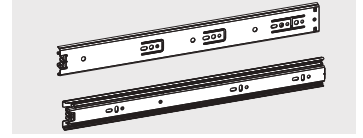

Tavsiye Edilen Vida



Kabin Ölçüleri

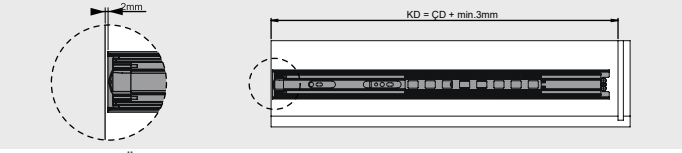

Çekmece Ölçüleri

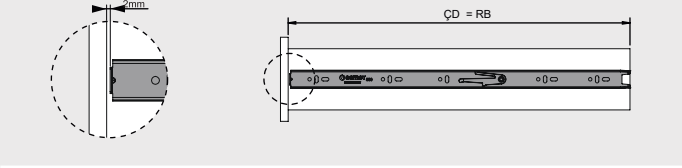

KİG : Kabin İç Genişliği
ÇG : Çekmece Genişliği

KD : Kabin Derinliği
ÇD : Çekmece Derinliği

RB : Ray Uzunluğu

Teknik Ölçüler

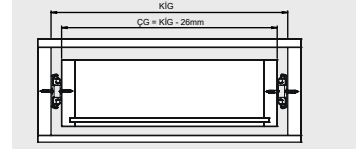

Parçalar

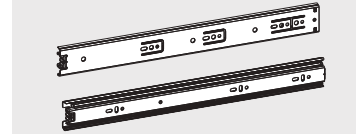

Tavsiye Edilen Vida



Kabin Ölçüleri

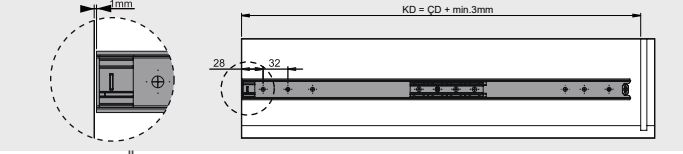

Çekmece Ölçüleri

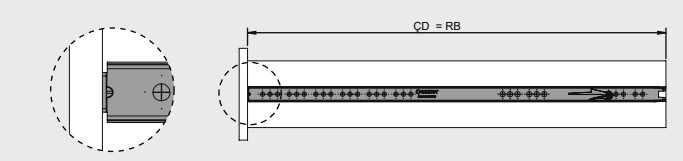

KİG : Kabin İç Genişliği
ÇG : Çekmece Genişliği

KD : Kabin Derinliği
ÇD : Çekmece Derinliği

RB : Ray Uzunluğu

Teknik Ölçüler

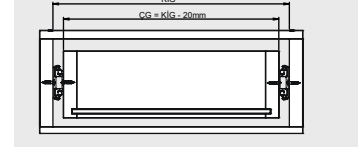

Parçalar

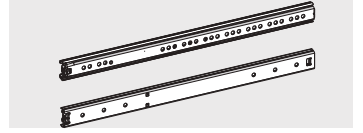

Tavsiye Edilen Vida

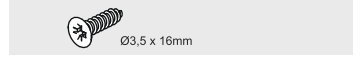

Kabin Ölçüleri

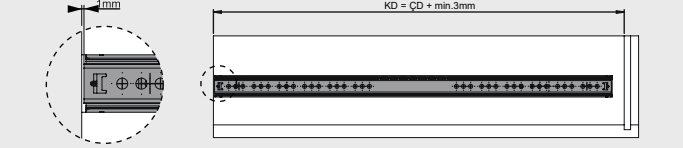

Çekmece Ölçüleri

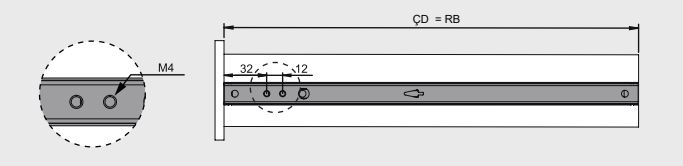

KİG : Kabin İç Genişliği
ÇG : Çekmece Genişliği

KD : Kabin Derinliği
ÇD : Çekmece Derinliği

RB : Ray Uzunluğu

Teknik Ölçüler

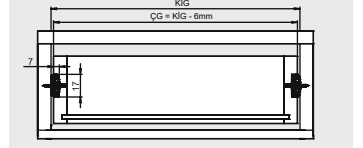

Parçalar

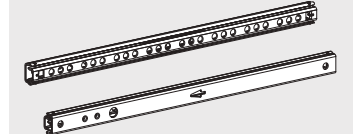

Tavsiye Edilen Vida



46 mm FRENLİ TAM AÇILIM RAY SİSTEMİ

Ürün Kodu Parlak	Ürün Kodu Mat	Ürün Kodu Siyah	Ray Boyu mm	Çalışma Mesafesi mm	Tağırma Kapasitesi kg	Koli Adet Takım
11662152000	11662452000	11662552000	300	252	30	12
11662153000	11662453000	11662553000	350	318	30	12
11662154000	11662454000	11662554000	400	385	30	12
11662155000	11662455000	11662555000	450	450	30	12
11662156000	11662456000	11662556000	500	500	30	12
11662157000	11662457000	11662557000	550	550	30	12
11662158000	11662458000	11662558000	600	600	30	12
11662159000	11662459000	11662559000	650	650	30	12
11662160000	11662460000	11662560000	700	700	30	12

46 mm TAM AÇILIM RAY SİSTEMİ

Ürün Kodu Parlak	Ürün Kodu Mat	Ürün Kodu Siyah	Ray Boyu mm	Çalışma Mesafesi mm	Tağırma Kapasitesi kg	Koli Adet Takım
11661151000	11661451000	11661551000	250	250	45	12
11661152000	11661452000	11661552000	300	295	45	12
11661153000	11661453000	11661553000	350	354	45	12
11661154000	11661454000	11661554000	400	404	45	12
11661155000	11661455000	11661555000	450	447	45	12
11661156000	11661456000	11661556000	500	503	45	12
11661157000	11661457000	11661557000	550	560	45	12
11661158000	11661458000	11661558000	600	610	45	12
11661159000	11661459000	11661559000	650	660	45	12
11661160000	11661460000	11661560000	700	710	45	12

43 mm TAM AÇILIM RAY SİSTEMİ

Ürün Kodu Parlak	Ürün Kodu Mat	Ray Boyu mm	Çalışma Mesafesi mm	Tağırma Kapasitesi kg	Koli Adet Takım
11651151000	11651451000	250	250	25	12
11651152000	11651452000	300	295	25	12
11651153000	11651453000	350	354	25	12
11651154000	11651454000	400	404	25	12
11651155000	11651455000	450	447	25	12
11651156000	11651456000	500	503	25	12
11651157000	11651457000	550	560	25	12
11651158000	11651458000	600	610	25	12
11651159000	11651459000	650	660	25	12
11651160000	11651460000	700	710	25	12

35 mm FRENLİ TAM AÇILIM RAY SİSTEMİ

Ürün Kodu Parlak	Ürün Kodu Mat	Ray Boyu mm	Çalışma Mesafesi mm	Tağırma Kapasitesi kg	Koli Adet Takım
11642152000	11642452000	300	252	20	12
11642153000	11642453000	350	318	20	12
11642154000	11642454000	400	392	20	12
11642155000	11642455000	450	424	20	12
11642156000	11642456000	500	492	20	12
11642157000	11642457000	550	548	20	12
11642158000	11642458000	600	596	20	12
11642159000	11642459000	650	646	20	12
11642160000	11642460000	700	696	20	12

35 mm TAM AÇILIM RAY SİSTEMİ

Ürün Kodu Parlak	Ürün Kodu Mat	Ray Boyu mm	Çalışma Mesafesi mm	Taşıma Kapasitesi kg	Koli Adet Takım
11641151000	11641453000	250	254	25	12
11641152000	11641453000	300	285	25	12
11641153000	11641453000	350	334	25	12
11641154000	11641454000	400	404	25	12
11641155000	11641455000	450	447	25	12
11641156000	11641456000	500	503	25	12
11641157000	11641457000	550	554	25	12
11641158000	11641458000	600	610	25	12
11641159000	11641459000	650	660	25	12
11641160000	11641460000	700	710	25	12

27 mm MANDALLI KİSMİ AÇILIM RAY SİSTEMİ

Ürün Kodu Parlak	Ürün Kodu Mat	Ray Boyu mm	Çalışma Mesafesi mm	Taşıma Kapasitesi kg	Koli Adet Takım
11621105000	11621405000	310	204	15	24
11621106000	11621406000	342	236	15	24
11621107000	11621407000	374	268	15	24
11621108000	11621408000	406	300	15	24
11621109000	11621409000	438	332	15	24
11621110000	11621410000	502	396	15	24

27 mm KİSMİ AÇILIM RAY SİSTEMİ

Ürün Kodu Parlak	Ürün Kodu Mat	Ray Boyu mm	Çalışma Mesafesi mm	Taşıma Kapasitesi kg	Koli Adet Takım
11611102000	11611402000	214	132	15	24
11611103000	11611403000	246	164	15	24
11611104000	11611404000	278	196	15	24
11611105000	11611405000	310	204	15	24
11611106000	11611406000	342	236	15	24
11611107000	11611407000	374	268	15	24
11611108000	11611408000	406	301	15	24
11611109000	11611409000	438	333	15	24
11611110000	11611410000	502	397	15	24

17 mm KİSMİ AÇILIM RAY SİSTEMİ

Ürün Kodu Mat	Ray Boyu mm	Çalışma Mesafesi mm	Taşıma Kapasitesi kg	Koli Adet Takım
11601401000	185	107	10	50
11601402000	214	136	10	50
11601403000	246	168	10	50
11601404000	278	200	10	50
11601405000	310	207	10	50
11601406000	342	239	10	50
11601407000	374	271	10	50
11601408000	406	303	10	50
11601409000	438	335	10	50
11601410000	502	399	10	50

samet



www.sametglobal.com

 sametinternational

 samet.group

 SametGroup

 Samet Kalıp ve Madeni Eşya San. ve Tic. A.Ş.