

# ULTIMADESINGLE

Undermount Slide Systems



**samet**

## Ultimade Single Wooden Drawer Slide

---

ULTIMADE SINGLE Drawer Systems, which enable custom design applications, offers excellent mobility and exceed expectations for lightweight solutions. This single extension drawer slide is ideal for minor storage needs. ULTIMADE SINGLE's integrated adaptive oil braking system adds elegance to the soft closing action.

### Adaptive Braking Mechanism

---

The new integrated soft close system ensures gentle and quiet closing. Thanks to adaptive soft close technology, drawers can be closed softly with same smooth closing effect even if you change the load inside the drawer.



### SmartLock Locking System

---

The SmartLock locking system provides easy mounting and safety, as well as tool-free adjustment ensures precise finishing touches.

## Drawer and Cabinet Dimensions S-C (Lock-Fix)

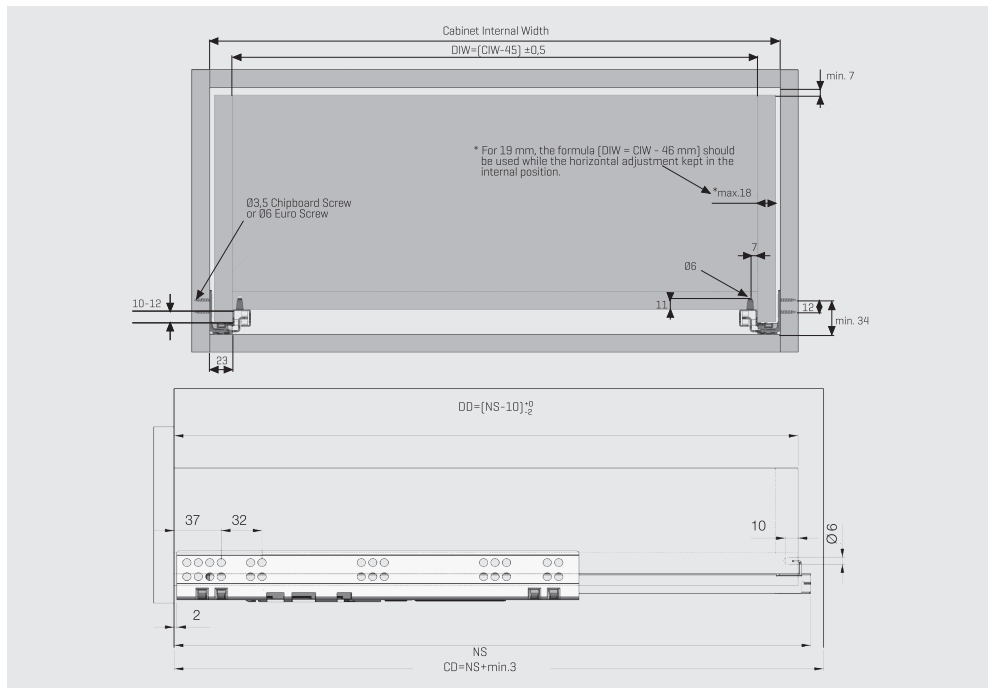

- CD Cabinet Depth
- CIW Cabinet Internal Width
- NS Nominal Size
- DIW Drawer Internal Width
- DD Drawer Depth

\*All dimensions in the diagram are in mm.

### Recommended Screws For Slide Assembly

Ø3,5x16 mm Chipboard Screw



Ø6,1x11,5 mm Euro Screw



## Single Extension Lock-Fix

Ultimade Single Drawer Slide Right-Left		
NOMINAL SIZE	CODE With Soft-Close	PACKING
350 mm	127222303	12 Set
400 mm	127222304	12 Set
450 mm	127222305	12 Set
500 mm	127222306	12 Set

SmartLock® Right-Left		
CODE Right	CODE Left	PACKING
12790773	12790774	120 Pcs

### Lock-Fix Drilling Holes

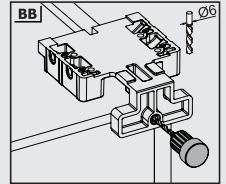
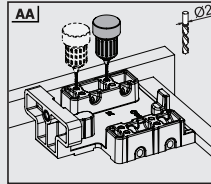
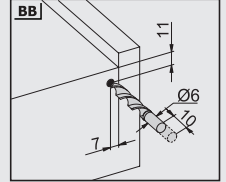
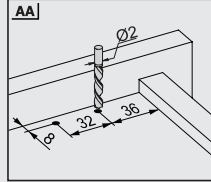
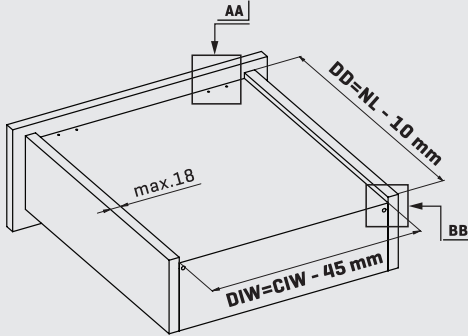





### Screw Location for the Slides

Screw the slide from marked holes.



[www.sametglobal.com](http://www.sametglobal.com)

-  sametinternational
-  samet\_global
-  SametGroup
-  Samet Kalıp ve Madeni Eşya San. ve Tic. A.Ş.