

Kabin Ölçüleri
Wymiary szafki

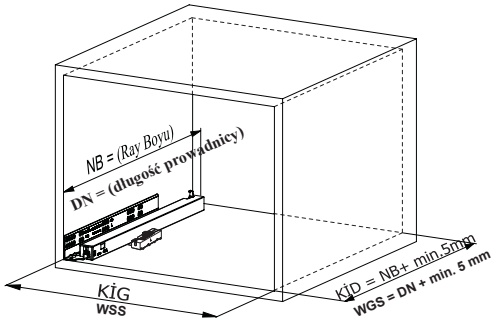

Kabin İç Geniřliđi	: KiG	Wewnętrzna szerokość szafki	: WSS
Kabin İç Derinliđi	: KiD	Wewnętrzna gębokość szafki	: WGS
Çekmece Derinliđi	: ÇD	Gębokość szuflady	: GS
Çekmece İç Geniřliđi	: ÇiG	Wewnętrzna szerokość szuflady	: WSSI
Nominal Boy (Ray boyu): NB		Długość nominalna	: DN

Tavsiye Edilen Vida ve Şablonlar
Zalecane wkręty i szablony

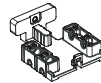
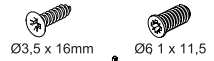

Smart Slide Mandala ve Tirnak Delme Şablonu
Szablon Smart Lock

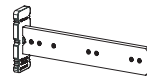

Smart El Tipi Ray Montaj Şablonu
Przyrząd Smart Drilling Jig



Smart Cevvelli Ray Montaj Şablonu
Przyrząd Smart Drilling Jig z podziałką

Rayların Vida Konum Ölçüleri
Rozmieszczenie wkrętów dla prowadnicy

Rayı, koyu renk ile işaretlenmiş deliklerden vidalayınız.
Przykręć prowadnicę w zaznaczonych otworach.

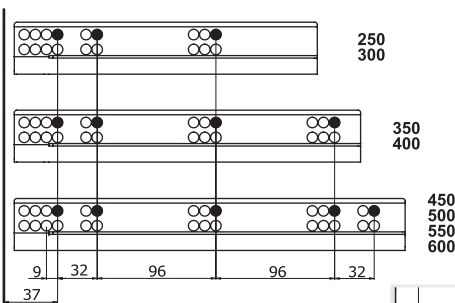

Bas - Aç Ayarı
Regulacja mechanizmu Push-Open

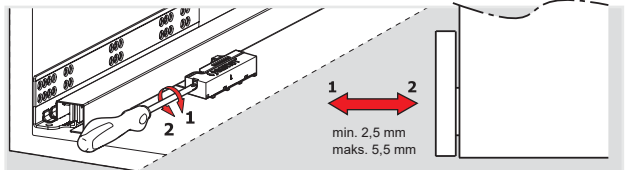
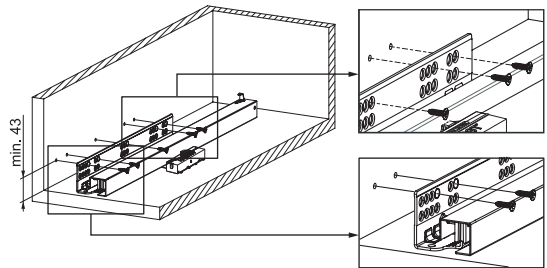

Çekmece Ölçüleri
Wymiary szuflady

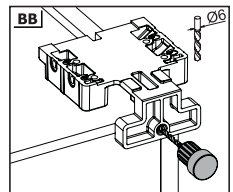
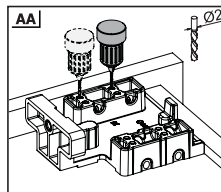
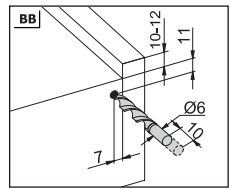
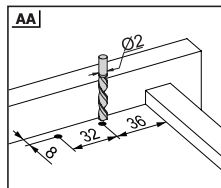
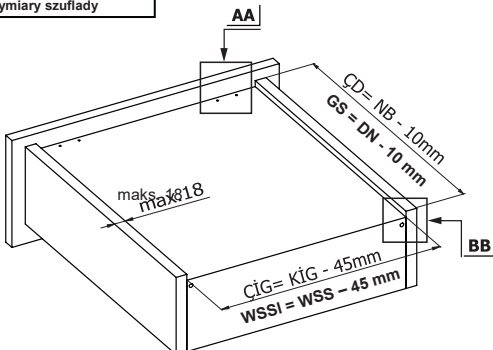

1

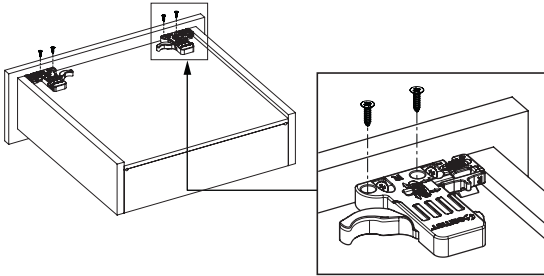

Not: Çekmece taban kalınlığı 12 mm'den küçük olduğunda, açılı mandal bağlama deliklerini kullanınız.

Uwaga: Jeśli szerokość drewnianego spodu jest mniejsza niż 12 mm, użyć otworów kątowych do montażu mechanizmu Smart Lock.

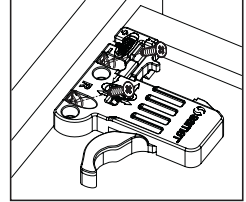
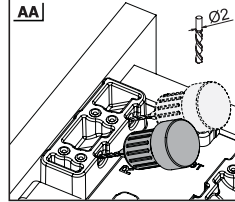

2

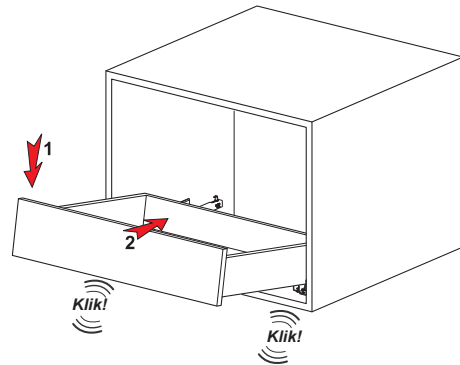

3

Somunu çevirerek, yukarıya doğru ayar yapabilirsiniz. Ustawienie w pionie można regulować za pomocą pokrętła.

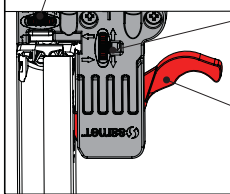
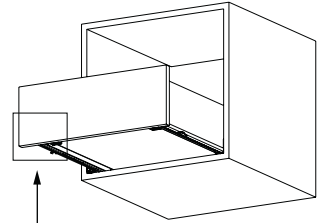

Somunu çevirerek, sağ-sol ayarını yapabilirsiniz. Ustawienie w kierunku lewo-prawo można regulować za pomocą pokrętła.

Mandal kollarına aynı anda basarak, çekmeceyi kolayca yerinden çıkarabilirsiniz. Aby wyciągnąć szufladę, wystarczy nacisnąć zatrzask Smart Lock

Smart El Tipi Ray
Montaj Şablonu
Przyrząd Smart Drilling Jig

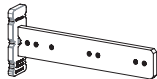

Kod / Kod

12799902

12799904

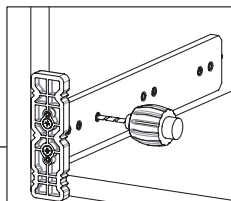
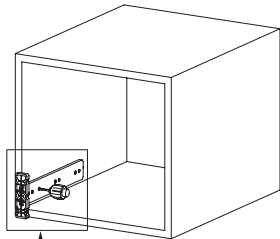

Smart Cetvelli Ray
Montaj Şablonu
Przyrząd Smart Drilling Jig z podziałką

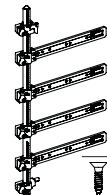

Kod / Kod

12799901

12799905

