

SMARTFULL

Undermount Slide Systems

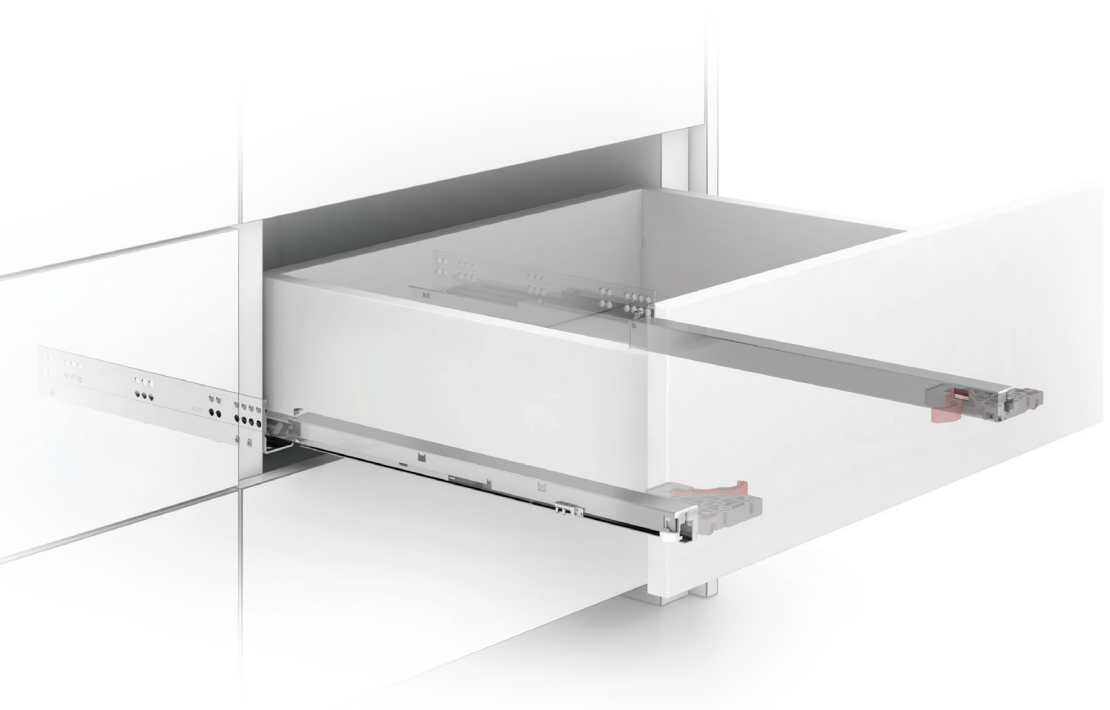

How many different ways could there be to open a SmartFull drawer ?

Soft Close Version

The new integrated soft close system ensures gentle and quiet closing. Thanks to adaptive soft close technology, drawers can be closed softly with same smooth closing effect even if you change the load inside the drawer.



Push - Open Version

SmartFull Drawer Systems "Push Open" function simplifies the use of non-handle drawers with a single touch movement.



Push - Open Soft Close Version

Now the SmartFull generation is integrated into the Soft-Close and Push-Open system at the same time. With this feature the drawer is upgraded to a very high quality and sophisticated design for the interior design world.



Smooth and Silent Movement

SmartFull is engineered to be functional for any drawers.

SmartFull extension allows you freedom in furniture design such as Day & Night furniture's, bathroom cabinet and also kitchen applications.

Due to special production method with low tolerances, SmartFull operates smooth and effortlessly all the time.

Nonstop Synchronization, provided by silicone wheel, ensures smooth and silent running action with lifetime durability.

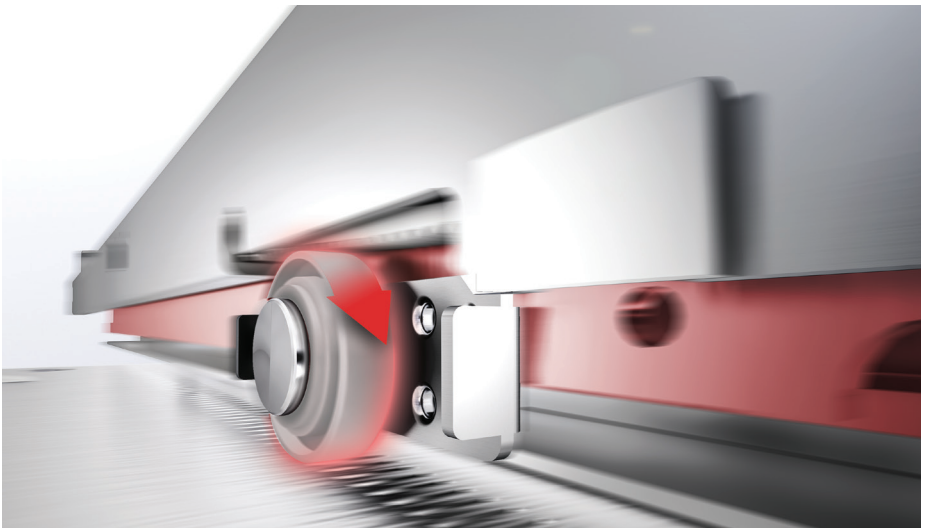

Lock-Fix and Pin-Fix Mechanism Options

Lock-Fix mechanism was especially designed for the quick and flexible installation process of SmartFull Drawer Systems. “Pin-Fix System” was particularly developed for industrial furniture producers to ensure ease and safety during installation.

With wide drawer size alternatives within a range of 250 mm to 600 mm, different requirements can be met, which ensures different solutions during furniture production. The possibility to lock as tight as desired ensures safety during drawer utilization.



Drawer and Cabinet Dimensions S-C

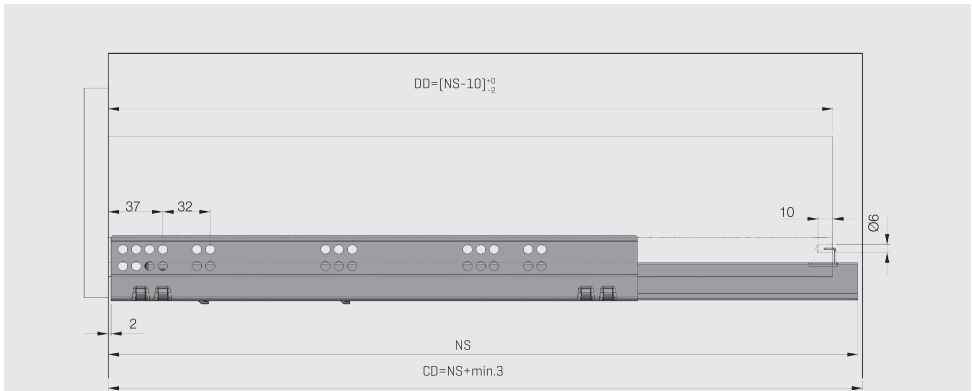
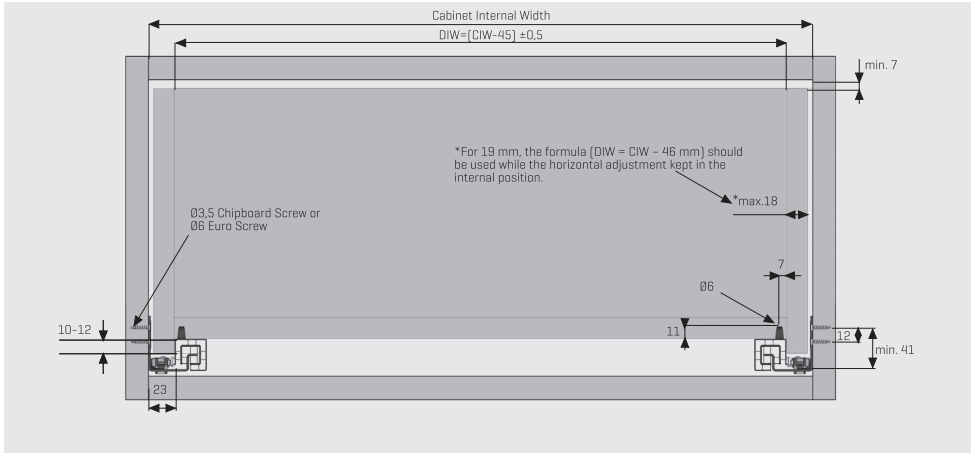

CIW: Cabinet Internal Width
 DIW: Drawer Internal Width

CD: Cabinet Depth
 DD: Drawer Depth

NS: Nominal Size

Lock - Fix Drilling Holes

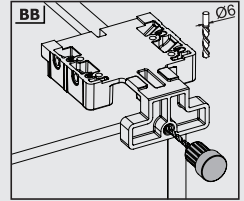
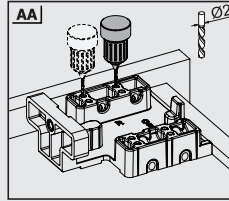
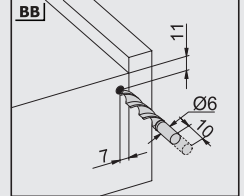
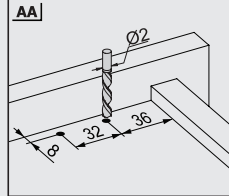
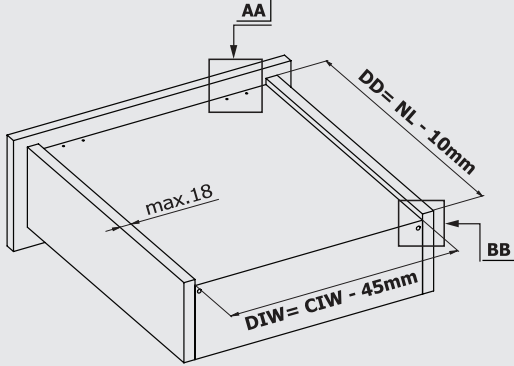

Screw the slide from marked holes.

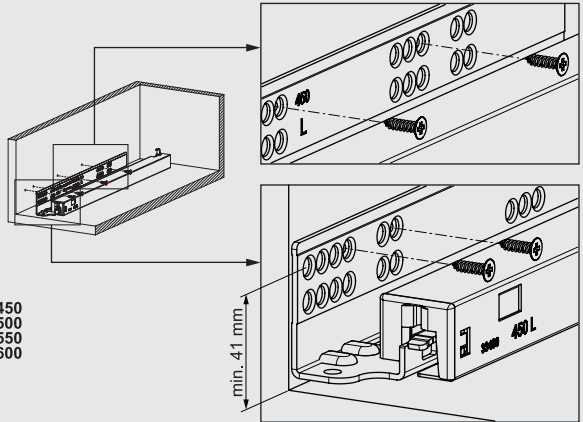
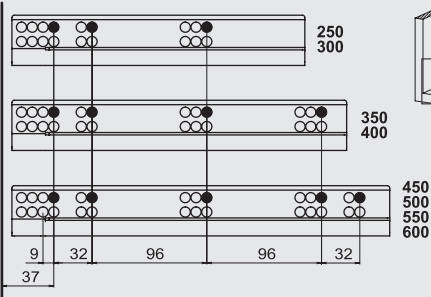

- CD Cabinet Depth
- CIW Cabinet Internal Width
- NS Nominal Size
- DIW Drawer Internal Width
- DD Drawer Depth

Recommended Screws for Slide Assembly

Ø3,5x16 mm Chipboard Screw



Ø6,1x11,5 mm Euro Screw



* All dimensions in the diagram are in mm

LOCK - FIX ASSEMBLY INSTRUCTIONS

1

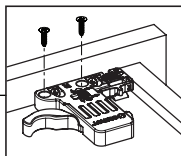
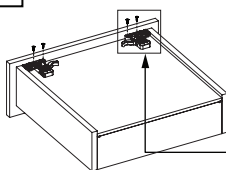

Note: Use angled holes to mount smart lock when wooden floor width is selected less than 12 mm.

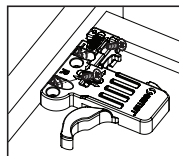
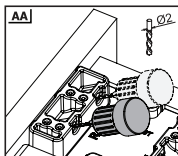

2

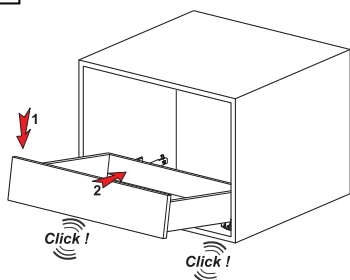

3

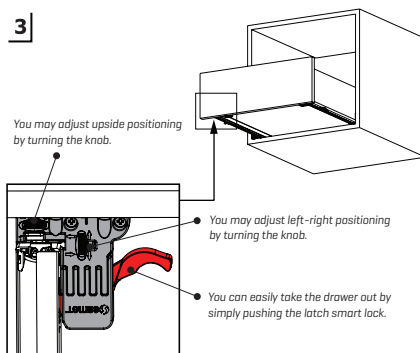





Full Extension Soft Close Lock Fix

SmartFull Drawer Slide Set		
NOMINAL SIZE	CODE With Brake	RETAIL PACKAGE
250 mm	12724023184	6 Set
300 mm	12724023284	6 Set
350 mm	12724023384	6 Set
400 mm	12724023484	6 Set
450 mm	12724023584	6 Set
500 mm	12724023684	6 Set
550 mm	12724023784	6 Set
600 mm	12724023884	6 Set

SmartLock® Right-Left		
CODE Right	CODE Left	PACKING
12790773	12790774	120 Pcs



www.greenplysamet.com

-  Greenply-Samet
-  GreenplySamet
-  GreenplySamet
-  GreenplySamet
-  GreenplySamet