

Solo Mech

Menteşesiz Tekli Kalkar Kapak Sistemi



samet



Hareketi sessiz ve büyölü kılan tasarım...

Solo-Mech, menteşesiz kullanıma yönelik geliştirilen yenilikçi teknolojsi ile açma-kapama hareketini kusursuz kılar.



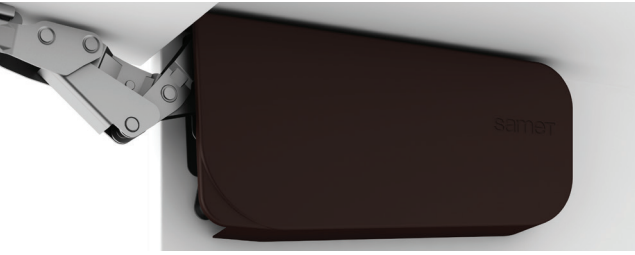

MOKA

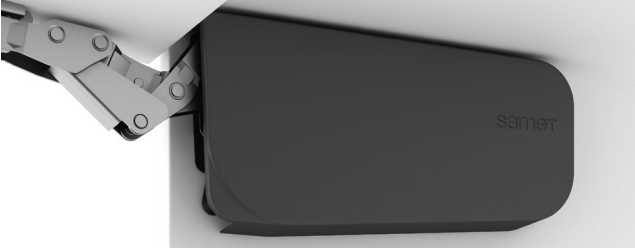

ANTRASİT

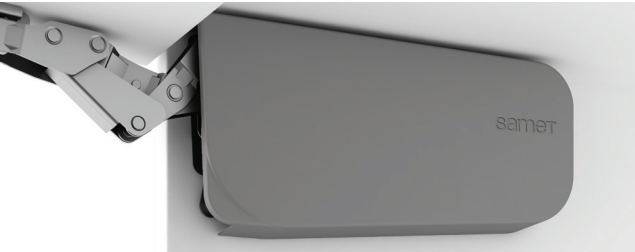

GRI



BEYAZ

Moka, Antrasit, Gri ve Beyaz renk seçenekleri ile üreticiye ilham veren tasarımlar sunar.



**Yavaş ve sessiz açılma-kapanma
özelliđi ile maksimum kullanım
konforu sağlar.**

Kademeli açılma mekanizması ile
istenilen seviyede durdurma imkanı
bulunmaktadır.

LGA sertifikalı geliştirilmiş
mekanik yapısı sayesinde
uzun yıllar, ilk günkü gibi
stabil çalışır.



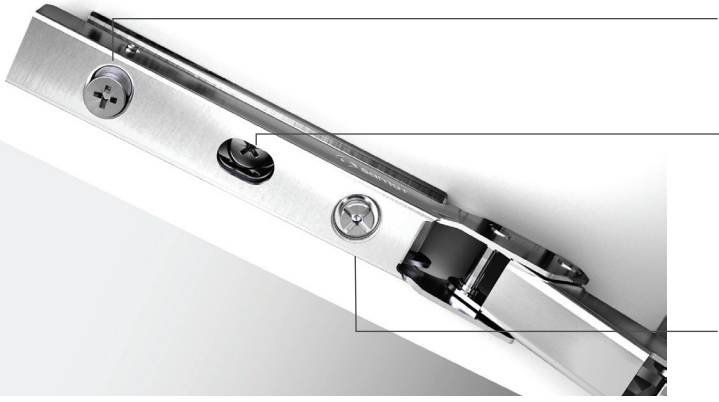

YUKARI
AŞAĞI



SOL
SAĞ



GERİ
İLERİ

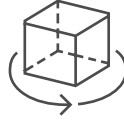

3D Ayar İmkani

Solo-Mech'in üç boyutlu ayar imkanı sağlayan mekanizması kusursuz bir montaj sağlar.

Solo-Mech Alüminyum Çevreveli Kapaklar



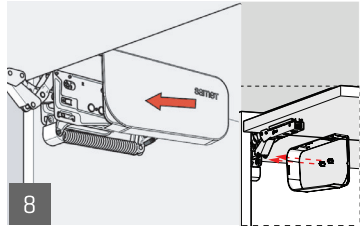
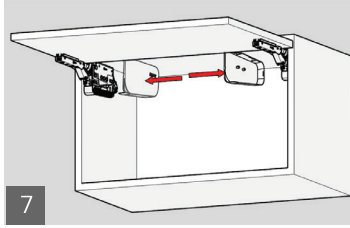
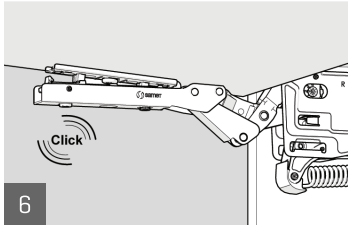
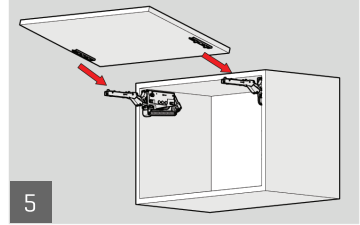
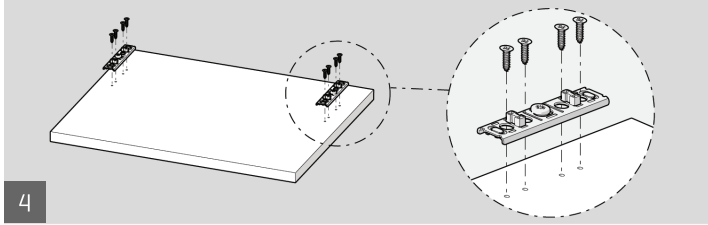
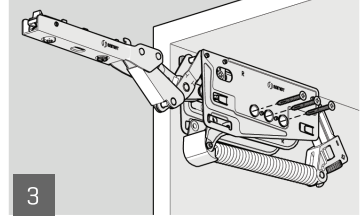
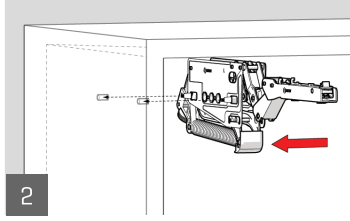
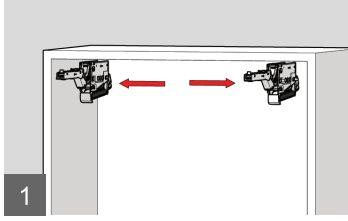

Kapağın 90° açılmasının gerekli olduğu yerler için stoper kullanılır.

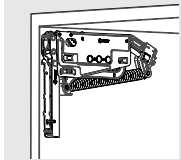

Kolu indiriniz.

3

Mevcut stoper parçasını çıkarınız.

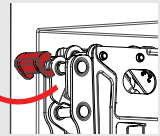
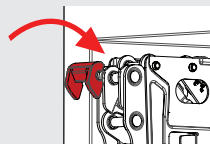

4

90° stoper parçasını takınız.

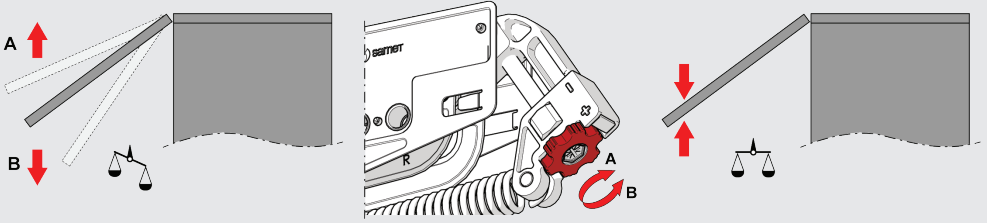

Kapak bırakıldığı zaman sabit durmayıp yukarı doğru çıkıyor ise "A" yönünde, aşağı doru iniyor ise "B" yönüne doğru çevirerek denge ayarını yapabilirsiniz.

Kapak hızlı veya yavaş kapanıyor ise belirtilen yerden ayar yaparak fren mekanizmasının gücünü ayarlayabilirsiniz.

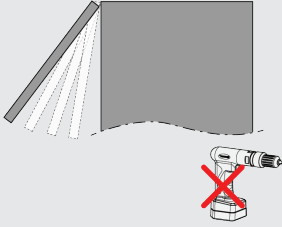

Ayar 1'de iken en düşük frenlemeyi 4'te iken en yüksek frenlemeyi yapmaktadır.

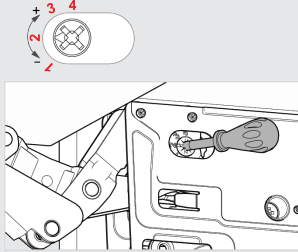

Önemli: Ayar mekanizmasını son noktasından itibaren zorlamayınız.

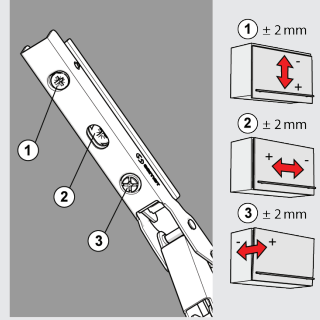

GÜVENLİK UYARISI!

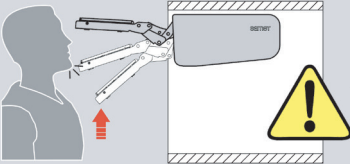

Dikkat:
Mekanizma kolu yukarıya fırlayıp yaralanmalara sebep olabilir.

TANIM

KOD

Solo-Mech Alüminyum Çerçeve Adaptörü

1249910

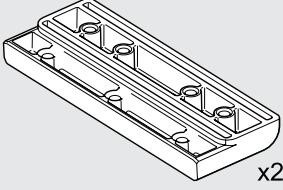

x10

M4

(DIN 7500M)

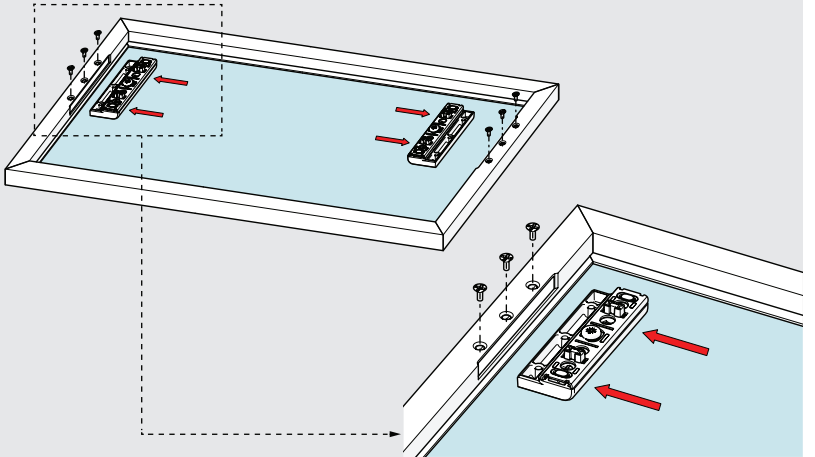
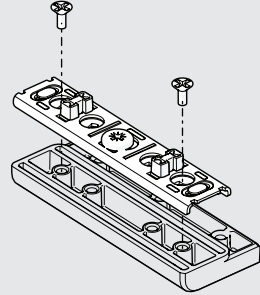
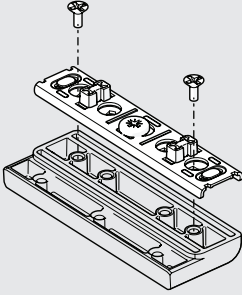

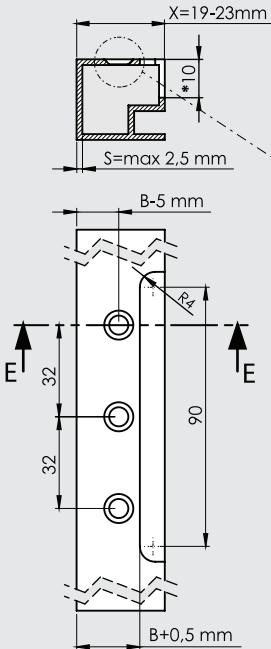
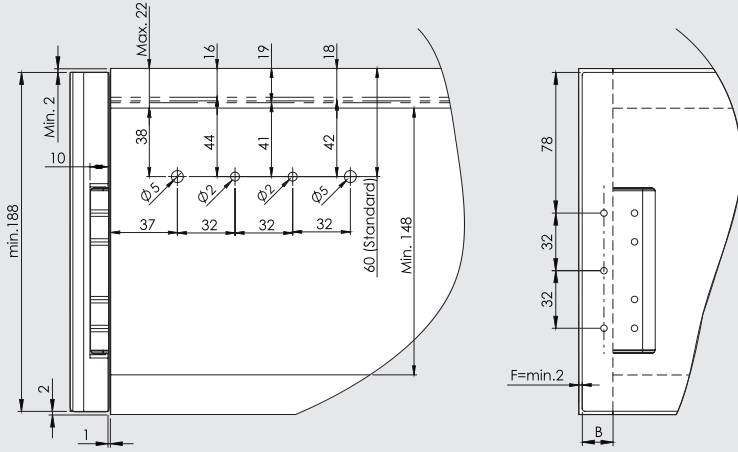

B+19 > X ise "Alüminyum Kapak Bağlantı Adaptörü" kullanılması gereklidir.

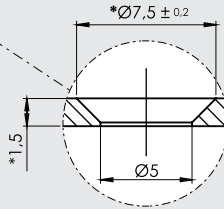

F : Fuga

B : Yan Kapak Binisi

S : Profil Malzeme Kalınlığı

X : Profil Geniřlięi

19mm geniřlięindeki Alüminyum profillerde B= max.17mm'dir.

Önemli

*Malzeme kalınlığı [S] deęiřmesi durumunda uygulama ölçüleri yeniden hesaplanmalıdır.

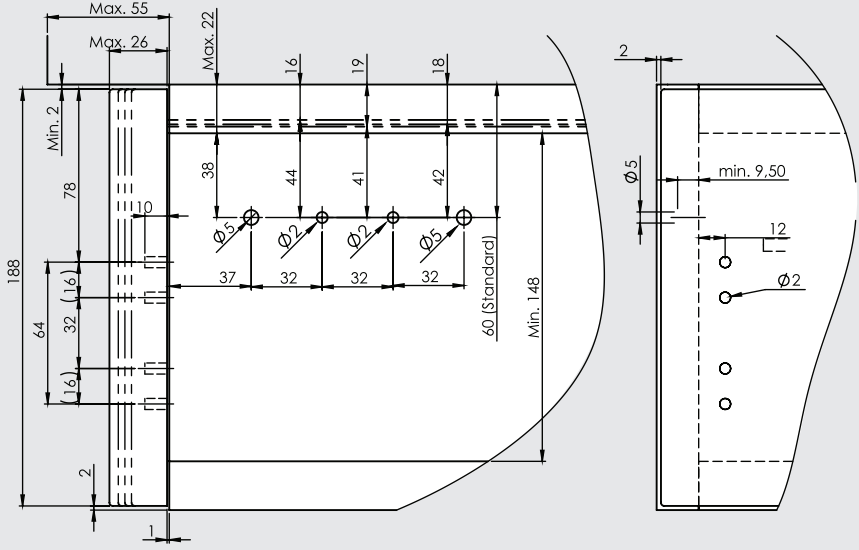

KABİN YÜKSEKLİĞİ	GÜÇ ÜNİTESİ	A1		B1		C1	
		min. kg	max. kg	min. kg	max. kg	min. kg	max. kg
200 mm		3,6	6,5	5	9,7	7	14,7
201-250 mm		3,4	5,3	4	7,5	5,5	12,2
251-300 mm		1,9	4,9	3	5,9	4,5	9,9
301-350 mm		1,6	3,6	2,8	5	4	7,9
351-400 mm		1,4	3,1	2,4	4,2	3,6	7,2
401-450 mm		1,3	2,8	2,2	3,8	3,2	6,3
451-500 mm		1,2	2,5	2	3,4	2,8	5,5
501-550 mm		1	2,2	1,75	3	2,6	5,1
551-600 mm		0,95	2	1,7	2,8	2,5	4,6

Kesişen alanlarda daha kuvvetli mekanizma önerilir.

Solo-Mech Mentşesiz Tekli Kalkar Kapak Mekanizması Set Paket

KOD	TANIM	GÜÇ	RENK	AMBALAJ
12417610001001	Solo-Mech Mentşesiz Tekli Kalkar Kapak Sistemi	A1	Beyaz	1 Takım/Koli
12417610003001	Solo-Mech Mentşesiz Tekli Kalkar Kapak Sistemi	A1	Gri	1 Takım/Koli
12417610006001	Solo-Mech Mentşesiz Tekli Kalkar Kapak Sistemi	A1	Mocha	1 Takım/Koli
12417610007001	Solo-Mech Mentşesiz Tekli Kalkar Kapak Sistemi	A1	Antrasit	1 Takım/Koli
12417710001001	Solo-Mech Mentşesiz Tekli Kalkar Kapak Sistemi	B1	Beyaz	1 Takım/Koli
12417710003001	Solo-Mech Mentşesiz Tekli Kalkar Kapak Sistemi	B1	Gri	1 Takım/Koli
12417710006001	Solo-Mech Mentşesiz Tekli Kalkar Kapak Sistemi	B1	Mocha	1 Takım/Koli
12417710007001	Solo-Mech Mentşesiz Tekli Kalkar Kapak Sistemi	B1	Antrasit	1 Takım/Koli
12417810001001	Solo-Mech Mentşesiz Tekli Kalkar Kapak Sistemi	C1	Beyaz	1 Takım/Koli
12417810003001	Solo-Mech Mentşesiz Tekli Kalkar Kapak Sistemi	C1	Gri	1 Takım/Koli
12417810006001	Solo-Mech Mentşesiz Tekli Kalkar Kapak Sistemi	C1	Mocha	1 Takım/Koli
12417810007001	Solo-Mech Mentşesiz Tekli Kalkar Kapak Sistemi	C1	Antrasit	1 Takım/Koli

Solo-Mech Mentşesiz Tekli Kalkar Kapak Mekanizması Endüstriyel Paket

KOD	TANIM	GÜÇ	TARAF	AMBALAJ
124176200	Solo-Mech Mentşesiz Tekli Kalkar Kapak Mekanizması Endüstriyel Paket	A1	Sağ	10 Adet/Koli
124176300	Solo-Mech Mentşesiz Tekli Kalkar Kapak Mekanizması Endüstriyel Paket	A1	Sol	10 Adet/Koli
124177200	Solo-Mech Mentşesiz Tekli Kalkar Kapak Mekanizması Endüstriyel Paket	B1	Sağ	10 Adet/Koli
124177300	Solo-Mech Mentşesiz Tekli Kalkar Kapak Mekanizması Endüstriyel Paket	B1	Sol	10 Adet/Koli
124178200	Solo-Mech Mentşesiz Tekli Kalkar Kapak Mekanizması Endüstriyel Paket	C1	Sağ	10 Adet/Koli
124178300	Solo-Mech Mentşesiz Tekli Kalkar Kapak Mekanizması Endüstriyel Paket	C1	Sol	10 Adet/Koli

Solo-Mech Mentşesiz Tekli Kalkar Kapak Mekanizması Endüstriyel Paket - Kapaklar

KOD	TANIM	GÜÇ	TARAF	AMBALAJ
124179201001	Solo-Mech Mentşesiz Tekli Kalkar Kapak Sistemi Dekoratif Kapak	Beyaz	Sağ Kapak	10 Adet / Koli
124179203001	Solo-Mech Mentşesiz Tekli Kalkar Kapak Sistemi Dekoratif Kapak	Gri	Sağ Kapak	10 Adet / Koli
124179206001	Solo-Mech Mentşesiz Tekli Kalkar Kapak Sistemi Dekoratif Kapak	Mocha	Sağ Kapak	10 Adet / Koli
124179207001	Solo-Mech Mentşesiz Tekli Kalkar Kapak Sistemi Dekoratif Kapak	Antrasit	Sağ Kapak	10 Adet / Koli
124179301001	Solo-Mech Mentşesiz Tekli Kalkar Kapak Sistemi Dekoratif Kapak	Beyaz	Sol Kapak	10 Adet / Koli
124179303001	Solo-Mech Mentşesiz Tekli Kalkar Kapak Sistemi Dekoratif Kapak	Gri	Sol Kapak	10 Adet / Koli
124179306001	Solo-Mech Mentşesiz Tekli Kalkar Kapak Sistemi Dekoratif Kapak	Mocha	Sol Kapak	10 Adet / Koli
124179307001	Solo-Mech Mentşesiz Tekli Kalkar Kapak Sistemi Dekoratif Kapak	Antrasit	Sol Kapak	10 Adet / Koli

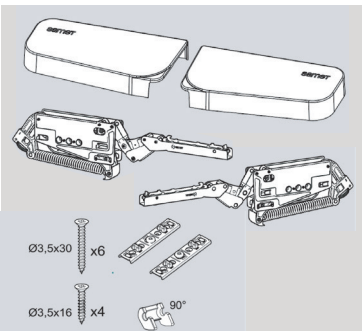

samet



www.sametglobal.com

 [sametinternational](#)

 [samet.group](#)

 [SametGroup](#)

 [Samet Kalıp ve Madeni Eşya San. ve Tic. A.Ş.](#)