

ULTIMADESINGLE

Single Extension Wooden Drawer Slide



samet

Ultimade Slide Single Extension Wooden Drawer Slide

- ULTIMADE SLIDE Drawer Systems, which enable custom design applications, offers excellent mobility and exceed expectations for lightweight solutions.
- ULTIMADE SLIDE's integrated oil braking system adds elegance to the soft closing action.

Adaptive Braking Mechanism

Ultimade Slide Drawer Systems state-of-art adaptive braking mechanism, gives drawers an excellent soft closing action.



Thanks to the superior SAMET technology, the light and quiet opening action combined with smooth running movement, maximizes the comfort of drawer use.

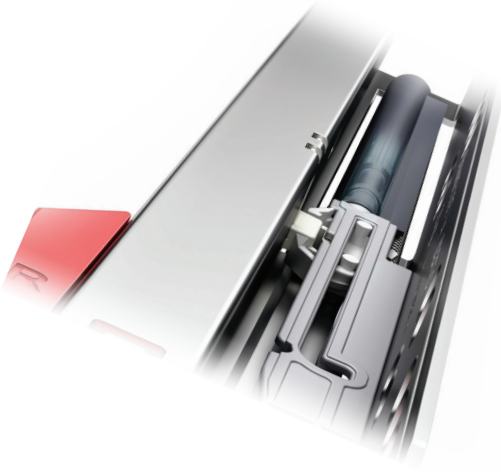

SmartLock Loking System

The SmartLock locking system provides easy mounting and safety, as well as tool-free adjustment ensures precise finishing touches.



Drawer and Cabinet Dimensions S-C [Lock Fix]

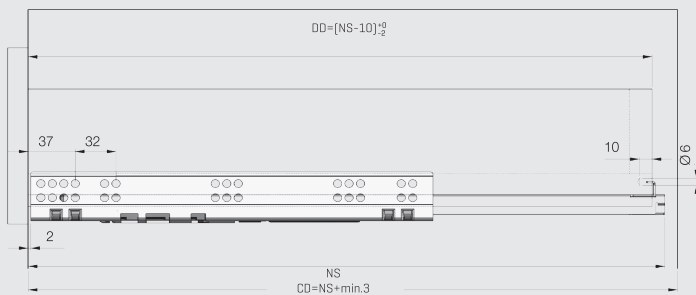
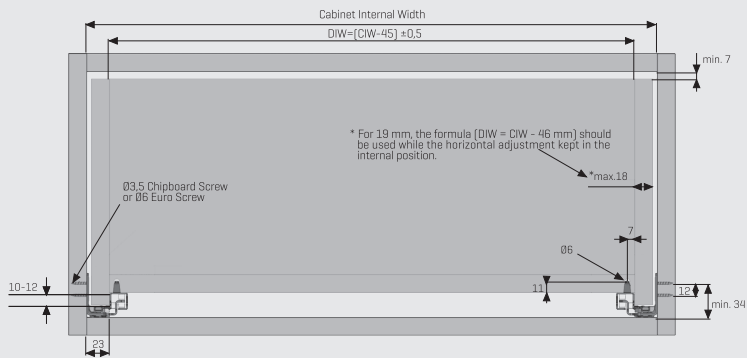

- CD Cabinet Depth
- CIW Cabinet Internal Width
- NS Nominal Size
- DIW Drawer Internal Width
- DD Drawer Depth

* All dimensions in the diagram are in mm

Recommended Screws For Rail Assembly for Assembly

Ø3,5x16 mm Chipboard Screw



Ø6,1x11,5 mm Euro Screw



Lock - Fix Drilling Holes

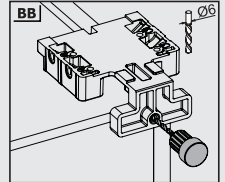
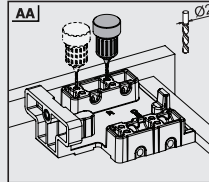
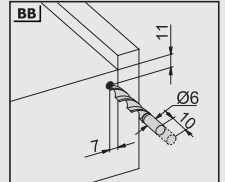
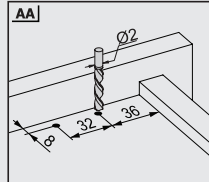
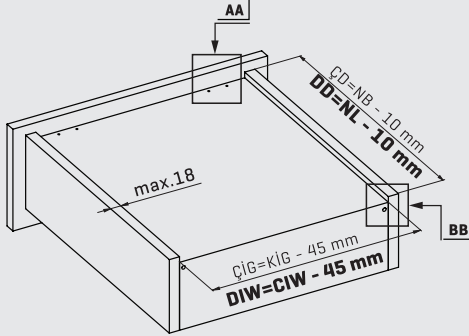

Screw Location for the Slides

Screw the slide from marked holes.



Single Extension Lock Fix

Smart Slide Drawer Slide Right-Left

NOMINAL SIZE	CODE With Soft Close	PACKING
350 mm	127222303	12 Set
400 mm	127222304	12 Set
450 mm	127222305	12 Set
500 mm	127222306	12 Set

SmartLock[®] Right-Left

CODE Right	CODE Left	PACKING
12790773	12790774	120 Pcs

samet



www.sametglobal.com

 sametinternational

 samet_global

 SametGroup

 Samet Kalıp ve Madeni Eşya San. ve Tic. A.Ş.