

slidea

Correderas de Cajón de Nueva Generación



samet

Un nuevo paso hacia la perfección...

Slidea, una parte inseparable de los ambientes elegantes y funcionales, aporta en muchos aspectos una comprensión única del concepto de cajón, desde elegancia y funcionalidad hasta practicidad y durabilidad.

¡Slidea es el nuevo nombre del Sistema de Correderas!



Slidea Push - Open

Gracias al sistema Slidea Push Open de ahora en adelante, sus cajones solo necesitan un suave toque para abrirse. Amplíe su libertad de diseño con cajones sin tiradores.



Slidea Soft - Close

Gracias a la tecnología de vanguardia del nuevo amortiguador hidráulico, la funcionalidad y la calidad se abrazan con las correderas Slidea. Disfrutará de la comodidad de una experiencia de cierre suave en todo momento.



slidea

Correderas de Cajón de Nueva Generación

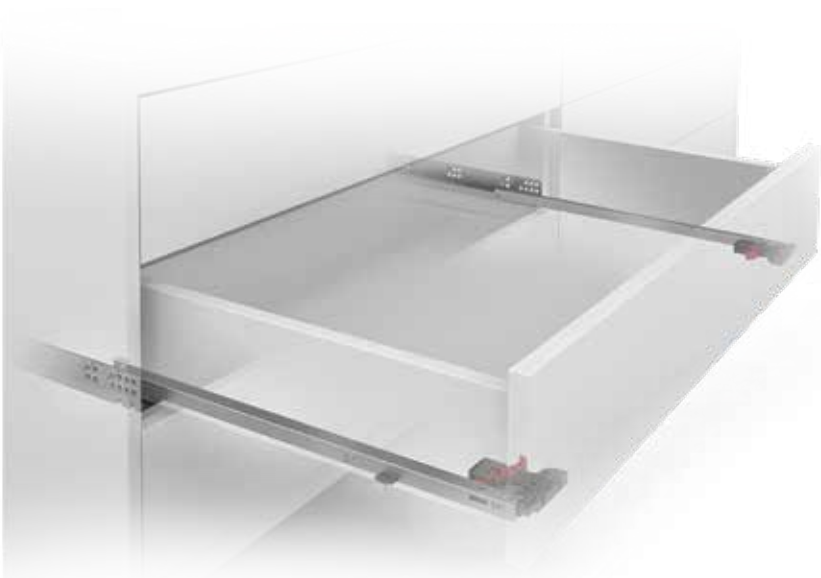

Dimensiones de Cajones y Muebles P-O / S-C [Ganchos]

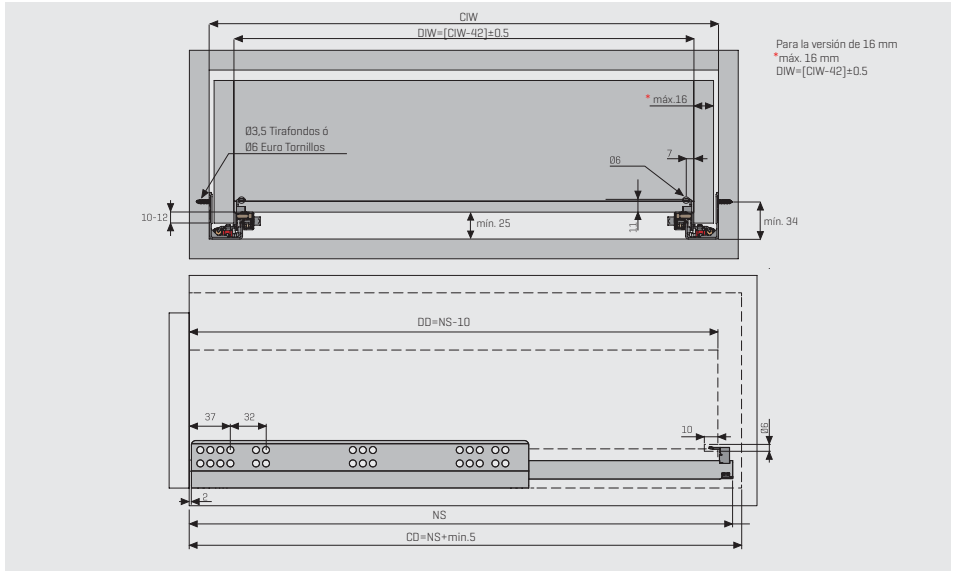

Dimensiones de Cajones y Muebles P-O / S-C [Pin Fix]

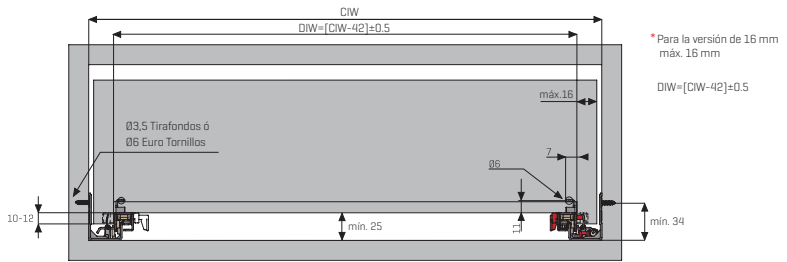

Ganchos Orificios Fijación [16 mm]

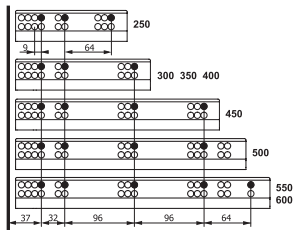

Ganchos Orificios Fijación [18 mm]

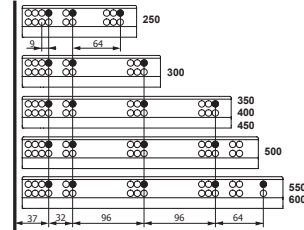

Pin-Fix Orificios Fijación [16-18 mm]

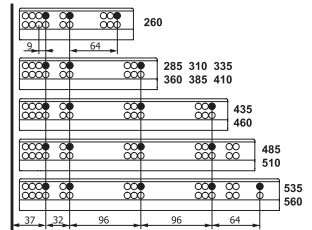

Extracción Parcial Ganchos [16mm]

Slidea Corredera Derecha / Izquierda			
MEDIDA NOMINAL	CÓDIGO con freno	CÓDIGO sin freno	EMBALAJE
250 mm	12722821	12722811	12 Set
300 mm	12722822	12722812	12 Set
350 mm	12722823	12722813	12 Set
400 mm	12722824	12722814	12 Set
450 mm	12722825	12722815	12 Set
500 mm	12722826	12722816	12 Set
550 mm	12722827	12722817	12 Set
600 mm	12722828	12722818	12 Set

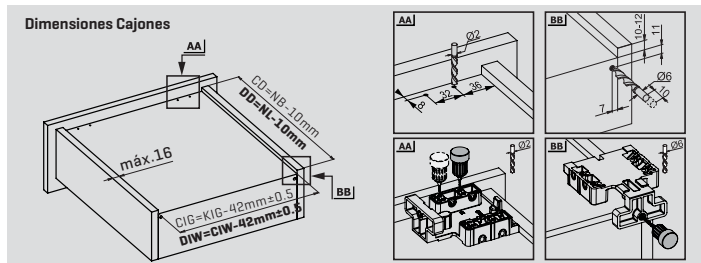

Empaquetado Industrial con freno			
MEDIDA NOMINAL	CÓDIGO Derecha	CÓDIGO Izquierda	EMBALAJE
250 mm	12722851	12722861	24 Pcs
300 mm	12722852	12722862	24 Pcs
350 mm	12722853	12722863	24 Pcs
400 mm	12722854	12722864	24 Pcs
450 mm	12722855	12722865	24 Pcs
500 mm	12722856	12722866	24 Pcs
550 mm	12722857	12722867	24 Pcs
600 mm	12722858	12722868	24 Pcs

Empaquetado Industrial sin freno			
MEDIDA NOMINAL	Código Derecha	CÓDIGO Izquierda	EMBALAJE
250 mm	12722831	12722841	24 Pcs
300 mm	12722832	12722842	24 Pcs
350 mm	12722833	12722843	24 Pcs
400 mm	12722834	12722844	24 Pcs
450 mm	12722835	12722845	24 Pcs
500 mm	12722836	12722846	24 Pcs
550 mm	12722837	12722847	24 Pcs
600 mm	12722838	12722848	24 Pcs

Extracción Parcial Push Open Ganchos [16mm]

Slidea Corredera Derecha-Izquierda			
MEDIDA NOMINAL	CÓDIGO	CÓDIGO REGULABLE	EMBALAJE
250 mm	12723511	12723711	12 Set
300 mm	12723512	12723712	12 Set
350 mm	12723513	12723713	12 Set
400 mm	12723514	12723714	12 Set
450 mm	12723515	12723715	12 Set
500 mm	12723516	12723716	12 Set
550 mm	12723517	12723717	12 Set
600 mm	12723518	12723718	12 Set

Ganchos Derecha-Izquierda		
CÓDIGO Derecha	CÓDIGO Izquierda	EMBALAJE
12790791	12790792	100 Pcs

Empaquetado Industrial			
MEDIDA NOMINAL	CÓDIGO Derecha	CÓDIGO Izquierda	EMBALAJE
250 mm	12723521	12723531	24 Pcs
300 mm	12723522	12723532	24 Pcs
350 mm	12723523	12723533	24 Pcs
400 mm	12723524	12723534	24 Pcs
450 mm	12723525	12723535	24 Pcs
500 mm	12723526	12723536	24 Pcs
550 mm	12723527	12723537	24 Pcs
600 mm	12723528	12723538	24 Pcs

Empaquetado Industrial				
MEDIDA NOMINAL	Regulable Derecha	CÓDIGO Regulable Derecha	CÓDIGO Regulable Izquierda	EMBALAJE
250 mm		12723721	12723731	24 Pcs
300 mm		12723722	12723732	24 Pcs
350 mm		12723723	12723733	24 Pcs
400 mm		12723724	12723734	24 Pcs
450 mm		12723725	12723735	24 Pcs
500 mm		12723726	12723736	24 Pcs
550 mm		12723727	12723737	24 Pcs
600 mm		12723728	12723738	24 Pcs

Extracción Parcial Pin Fix [16mm]

Slidea Corredera Derecha / Izquierda			
MEDIDA NOMINAL	CÓDIGO con freno	CÓDIGO sin freno	EMBALAJE
260 mm	1272292260	1272291260	12 Set
285 mm	1272292285	1272291285	12 Set
310 mm	1272292310	1272291310	12 Set
335 mm	1272292335	1272291335	12 Set
360 mm	1272292360	1272291360	12 Set
385 mm	1272292385	1272291385	12 Set
410 mm	1272292410	1272291410	12 Set
435 mm	1272292435	1272291435	12 Set
460 mm	1272292460	1272291460	12 Set
485 mm	1272292485	1272291485	12 Set
510 mm	1272292510	1272291510	12 Set
535 mm	1272292535	1272291535	12 Set
560 mm	1272292560	1272291560	12 Set

Dimensiones Cajón

Debe perforar los agujeros antes de montar el cajón.

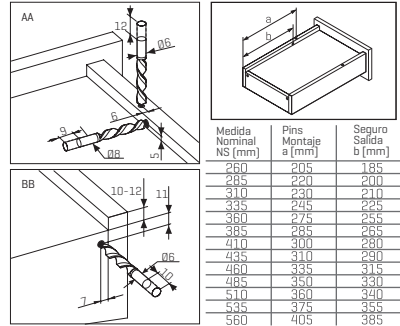
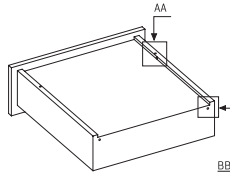

Empaquetado Industrial con freno			
MEDIDA NOMINAL	CÓDIGO Derecha	CÓDIGO Izquierda	EMBALAJE
260 mm	1272295260	1272296260	24 Pcs
285 mm	1272295285	1272296285	24 Pcs
310 mm	1272295310	1272296310	24 Pcs
335 mm	1272295335	1272296335	24 Pcs
360 mm	1272295360	1272296360	24 Pcs
385 mm	1272295385	1272296385	24 Pcs
410 mm	1272295410	1272296410	24 Pcs
435 mm	1272295435	1272296435	24 Pcs
460 mm	1272295460	1272296460	24 Pcs
485 mm	1272295485	1272296485	24 Pcs
510 mm	1272295510	1272296510	24 Pcs
535 mm	1272295535	1272296535	24 Pcs
560 mm	1272295560	1272296560	24 Pcs

Empaquetado Industrial sin freno			
MEDIDA NOMINAL	CÓDIGO Derecha	CÓDIGO Izquierda	EMBALAJE
260 mm	1272293260	1272294260	24 Pcs
285 mm	1272293285	1272294285	24 Pcs
310 mm	1272293310	1272294310	24 Pcs
335 mm	1272293335	1272294335	24 Pcs
360 mm	1272293360	1272294360	24 Pcs
385 mm	1272293385	1272294385	24 Pcs
410 mm	1272293410	1272294410	24 Pcs
435 mm	1272293435	1272294435	24 Pcs
460 mm	1272293460	1272294460	24 Pcs
485 mm	1272293485	1272294485	24 Pcs
510 mm	1272293510	1272294510	24 Pcs
535 mm	1272293535	1272294535	24 Pcs
560 mm	1272293560	1272294560	24 Pcs

Extracción Parcial Push Open Pin Fix [16mm]

Slidea Corredera Derecha-Izquierda			
MEDIDA NOMINAL	CÓDIGO	CÓDIGO REGULABLE	EMBALAJE
260 mm	1272354260	1272374260	12 Set
285 mm	1272354285	1272374285	12 Set
310 mm	1272354310	1272374310	12 Set
335 mm	1272354335	1272374335	12 Set
360 mm	1272354360	1272374360	12 Set
385 mm	1272354385	1272374385	12 Set
410 mm	1272354410	1272374410	12 Set
435 mm	1272354435	1272374435	12 Set
460 mm	1272354460	1272374460	12 Set
485 mm	1272354485	1272374485	12 Set
510 mm	1272354510	1272374510	12 Set
535 mm	1272354535	1272374535	12 Set
560 mm	1272354560	1272374560	12 Set

Empaquetado Industrial			
MEDIDA NOMINAL	CÓDIGO Derecha	CÓDIGO Izquierda	EMBALAJE
260 mm	1272355260	1272356260	24 Pcs
285 mm	1272355285	1272356285	24 Pcs
310 mm	1272355310	1272356310	24 Pcs
335 mm	1272355335	1272356335	24 Pcs
360 mm	1272355360	1272356360	24 Pcs
385 mm	1272355385	1272356385	24 Pcs
410 mm	1272355410	1272356410	24 Pcs
435 mm	1272355435	1272356435	24 Pcs
460 mm	1272355460	1272356460	24 Pcs
485 mm	1272355485	1272356485	24 Pcs
510 mm	1272355510	1272356510	24 Pcs
535 mm	1272355535	1272356535	24 Pcs
560 mm	1272355560	1272356560	24 Pcs

Empaquetado Industrial			
MEDIDA NOMINAL	CÓDIGO Derecha	CÓDIGO Izquierda	EMBALAJE
260 mm	1272375260	1272376260	24 Pcs
285 mm	1272375285	1272376285	24 Pcs
310 mm	1272375310	1272376310	24 Pcs
335 mm	1272375335	1272376335	24 Pcs
360 mm	1272375360	1272376360	24 Pcs
385 mm	1272375385	1272376385	24 Pcs
410 mm	1272375410	1272376410	24 Pcs
435 mm	1272375435	1272376435	24 Pcs
460 mm	1272375460	1272376460	24 Pcs
485 mm	1272375485	1272376485	24 Pcs
510 mm	1272375510	1272376510	24 Pcs
535 mm	1272375535	1272376535	24 Pcs
560 mm	1272375560	1272376560	24 Pcs

Extracción Parcial Lock Fix [18 mm]

Slidea Corredera Derecha / Izquierda			
MEDIDA NOMINAL	CÓDIGO con freno	CÓDIGO sin freno	EMBALAJE
250 mm	12722311	12722311	12 Set
300 mm	12722312	12722312	12 Set
350 mm	12722313	12722313	12 Set
400 mm	12722314	12722314	12 Set
450 mm	12722315	12722315	12 Set
500 mm	12722316	12722316	12 Set
550 mm	12722317	12722317	12 Set
600 mm	12722318	12722318	12 Set

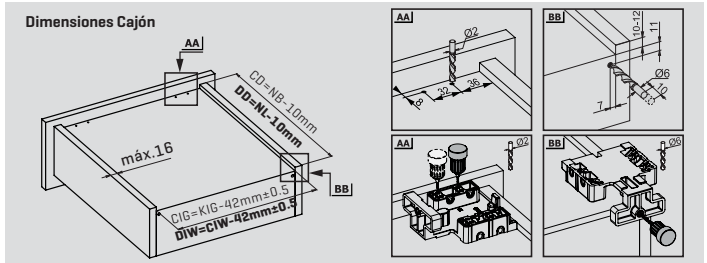

Empaquetado Industrial con freno			
MEDIDA NOMINAL	CÓDIGO Derecha	CÓDIGO Izquierda	EMBALAJE
250 mm	12722351	12722361	24 Pcs
300 mm	12722352	12722362	24 Pcs
350 mm	12722353	12722363	24 Pcs
400 mm	12722354	12722364	24 Pcs
450 mm	12722355	12722365	24 Pcs
500 mm	12722356	12722366	24 Pcs
550 mm	12722357	12722367	24 Pcs
600 mm	12722358	12722368	24 Pcs

Empaquetado Industrial sin freno			
MEDIDA NOMINAL	Código Derecha	CÓDIGO Izquierda	EMBALAJE
250 mm	12722331	12722361	24 Pcs
300 mm	12722332	12722362	24 Pcs
350 mm	12722333	12722363	24 Pcs
400 mm	12722334	12722364	24 Pcs
450 mm	12722335	12722365	24 Pcs
500 mm	12722336	12722366	24 Pcs
550 mm	12722337	12722367	24 Pcs
600 mm	12722338	12722368	24 Pcs

Extracción Parcial Push Open Lock Fix [18 mm]

Slidea Corredera Derecha-Izquierda			
MEDIDA NOMINAL	CÓDIGO	CÓDIGO AJUSTABLE	EMBALAJE
250 mm	12723411	12723611	12 Set
300 mm	12723412	12723612	12 Set
350 mm	12723413	12723613	12 Set
400 mm	12723414	12723614	12 Set
450 mm	12723415	12723615	12 Set
500 mm	12723416	12723616	12 Set
550 mm	12723417	12723617	12 Set
600 mm	12723418	12723618	12 Set

Sistema de bloqueo Derecha-Izquierda		
CÓDIGO Derecha	CÓDIGO Izquierda	EMBALAJE
12790791	12790792	100 Pcs

Empaquetado Industrial No ajustable			
MEDIDA NOMINAL	CÓDIGO Derecha	CÓDIGO Izquierda	EMBALAJE
250 mm	12723421	12723431	24 Pcs
300 mm	12723422	12723432	24 Pcs
350 mm	12723423	12723433	24 Pcs
400 mm	12723424	12723434	24 Pcs
450 mm	12723425	12723435	24 Pcs
500 mm	12723426	12723436	24 Pcs
550 mm	12723427	12723437	24 Pcs
600 mm	12723428	12723438	24 Pcs

Empaquetado Industrial Ajustable			
MEDIDA NOMINAL	CÓDIGO Derecha	CÓDIGO Izquierda	EMBALAJE
250 mm	12723621	12723631	24 Pcs
300 mm	12723622	12723632	24 Pcs
350 mm	12723623	12723633	24 Pcs
400 mm	12723624	12723634	24 Pcs
450 mm	12723625	12723635	24 Pcs
500 mm	12723626	12723636	24 Pcs
550 mm	12723627	12723637	24 Pcs
600 mm	12723628	12723638	24 Pcs

Extracción Parcial Pin Fix [18 mm]

Slidea Corredera Derecha / Izquierda			
MEDIDA NOMINAL	CÓDIGO con freno	CÓDIGO sin freno	EMBALAJE
260 mm	1272272260	1272271260	12 Set
285 mm	1272272285	1272271285	12 Set
310 mm	1272272310	1272271310	12 Set
335 mm	1272272335	1272271335	12 Set
360 mm	1272272360	1272271360	12 Set
385 mm	1272272385	1272271385	12 Set
410 mm	1272272410	1272271410	12 Set
435 mm	1272272435	1272271435	12 Set
460 mm	1272272460	1272271460	12 Set
485 mm	1272272485	1272271485	12 Set
510 mm	1272272510	1272271510	12 Set
535 mm	1272272535	1272271535	12 Set
560 mm	1272272560	1272271560	12 Set

Dimensiones Cajón

Debe perforar los agujeros antes de montar el cajón.

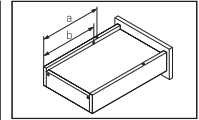
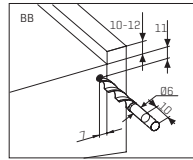
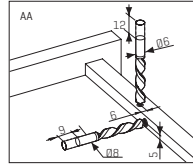
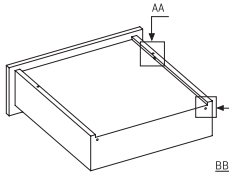

Tamaño Nominal Tm (mm)	Conector Pasador a (mm)	Pasador de seguridad b (mm)
260	205	185
285	220	200
310	230	210
335	245	225
360	275	255
385	285	265
410	300	280
435	310	290
460	335	315
485	350	330
510	360	340
535	375	355
560	405	385

Empaquetado Industrial con freno			
MEDIDA NOMINAL	CÓDIGO Derecha	CÓDIGO Izquierda	EMBALAJE
260 mm	1272275260	1272276260	24 Pcs
285 mm	1272275285	1272276285	24 Pcs
310 mm	1272275310	1272276310	24 Pcs
335 mm	1272275335	1272276335	24 Pcs
360 mm	1272275360	1272276360	24 Pcs
385 mm	1272275385	1272276385	24 Pcs
410 mm	1272275410	1272276410	24 Pcs
435 mm	1272275435	1272276435	24 Pcs
460 mm	1272275460	1272276460	24 Pcs
485 mm	1272275485	1272276485	24 Pcs
510 mm	1272275510	1272276510	24 Pcs
535 mm	1272275535	1272276535	24 Pcs
560 mm	1272275560	1272276560	24 Pcs

Empaquetado Industrial sin freno			
MEDIDA NOMINAL	CÓDIGO Derecha	CÓDIGO Izquierda	EMBALAJE
260 mm	1272273260	1272274260	24 Pcs
285 mm	1272273285	1272274285	24 Pcs
310 mm	1272273310	1272274310	24 Pcs
335 mm	1272273335	1272274335	24 Pcs
360 mm	1272273360	1272274360	24 Pcs
385 mm	1272273385	1272274385	24 Pcs
410 mm	1272273410	1272274410	24 Pcs
435 mm	1272273435	1272274435	24 Pcs
460 mm	1272273460	1272274460	24 Pcs
485 mm	1272273485	1272274485	24 Pcs
510 mm	1272273510	1272274510	24 Pcs
535 mm	1272273535	1272274535	24 Pcs
560 mm	1272273560	1272274560	24 Pcs

Extracción Parcial Push Open Pin Fix [18 mm]

Slidea Corredera Derecha-Izquierda			
MEDIDA NOMINAL	CÓDIGO	CÓDIGO AJUSTABLE	EMBALAJE
260 mm	1272344260	1272364260	12 Set
285 mm	1272344285	1272364285	12 Set
310 mm	1272344310	1272364310	12 Set
335 mm	1272344335	1272364335	12 Set
360 mm	1272344360	1272364360	12 Set
385 mm	1272344385	1272364385	12 Set
410 mm	1272344410	1272364410	12 Set
435 mm	1272344435	1272364435	12 Set
460 mm	1272344460	1272364460	12 Set
485 mm	1272344485	1272364485	12 Set
510 mm	1272344510	1272364510	12 Set
535 mm	1272344535	1272364535	12 Set
560 mm	1272344560	1272364560	12 Set

Empaquetado Industrial No ajustable			
MEDIDA NOMINAL	CÓDIGO Derecha	CÓDIGO Izquierda	EMBALAJE
260 mm	1272345260	1272346260	24 Pcs
285 mm	1272345285	1272346285	24 Pcs
310 mm	1272345310	1272346310	24 Pcs
335 mm	1272345335	1272346335	24 Pcs
360 mm	1272345360	1272346360	24 Pcs
385 mm	1272345385	1272346385	24 Pcs
410 mm	1272345410	1272346410	24 Pcs
435 mm	1272345435	1272346435	24 Pcs
460 mm	1272345460	1272346460	24 Pcs
485 mm	1272345485	1272346485	24 Pcs
510 mm	1272345510	1272346510	24 Pcs
535 mm	1272345535	1272346535	24 Pcs
560 mm	1272345560	1272346560	24 Pcs

Empaquetado Industrial Ajustable			
MEDIDA NOMINAL	CÓDIGO Derecha	CÓDIGO Izquierda	EMBALAJE
260 mm	1272365260	1272366260	24 Pcs
285 mm	1272365285	1272366285	24 Pcs
310 mm	1272365310	1272366310	24 Pcs
335 mm	1272365335	1272366335	24 Pcs
360 mm	1272365360	1272366360	24 Pcs
385 mm	1272365385	1272366385	24 Pcs
410 mm	1272365410	1272366410	24 Pcs
435 mm	1272365435	1272366435	24 Pcs
460 mm	1272365460	1272366460	24 Pcs
485 mm	1272365485	1272366485	24 Pcs
510 mm	1272365510	1272366510	24 Pcs
535 mm	1272365535	1272366535	24 Pcs
560 mm	1272365560	1272366560	24 Pcs

GANCHOS - FIJAR INSTRUCCIONES DE MONTAJE

1

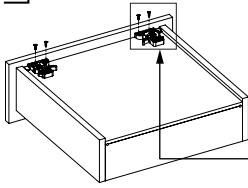

Nota: Use los orificios angulados para fijar el gancho cuando el espesor del fondo del cajón sea menor de 12 mm.

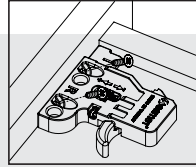
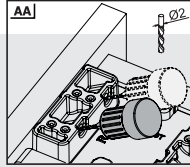
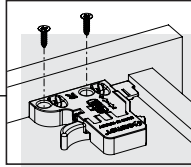

2

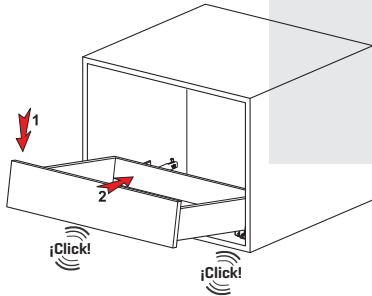

3

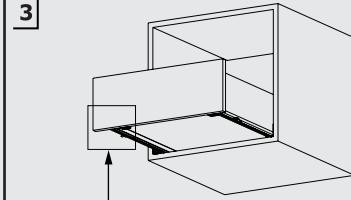

Puede ajustar hacia arriba girando la ruleta.

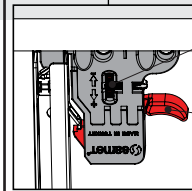

Puede sacar fácilmente el cajón simplemente presionando los pestillos de los ganchos

PIN - FIX INSTRUCCIONES MONTAJE

1

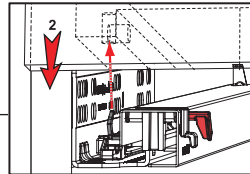
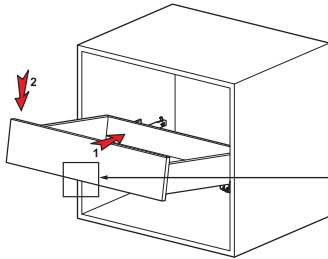

¡Importante!
Asegúrese de mantener abierto el pasador de seguridad antes de colocar el cajón.

2

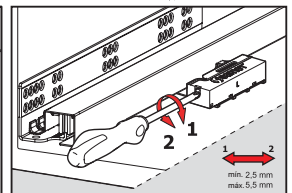
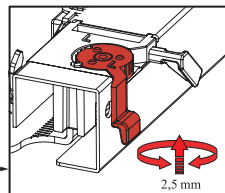
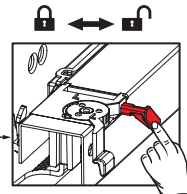
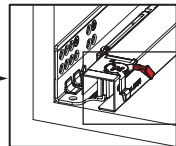
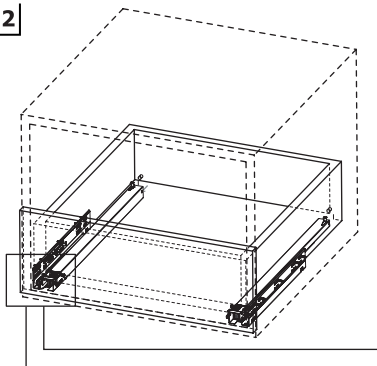

samET



samet.com.tr

-  SametGroup
-  SametGroup
-  Samet Kalıp ve Madeni Eşya San. ve Tic. A.Ş.
-  sametinternational