

Kabin Ölçüleri
Schranksabmessungen

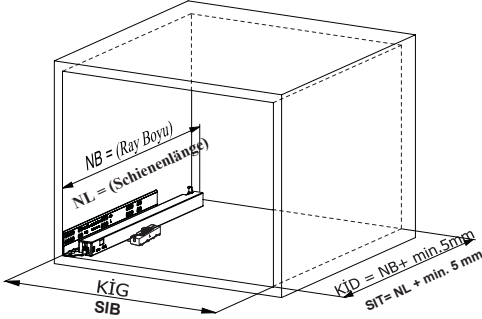

| | | | |
|----------------------------|-------|------------------------|--------|
| Kabin İç Geniřliđi | : KiG | Schrank-Innenbreite | : SIB |
| Kabin İç Derinliđi | : KİD | Schrank-Innentiefe | : SİT |
| Çekmece Derinliđi | : ÇD | Schubladentiefe | : SLT |
| Çekmece İç Geniřliđi | : ÇİG | Schubladen-Innenbreite | : SLİB |
| Nominal Boy (Ray boyu): NB | | Nennlänge | : NL |

Tavsiye Edilen Vida ve Şablonlar
Empfohlene Schrauben und Schablonen

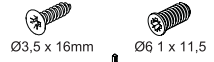

Smart Slide Mandala ve Tırnak Delme Şablonu

Smart Lock-Schablone

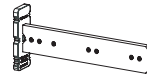

Smart El Tipi Ray Montaj Şablonu

Smart-Bohrschablone

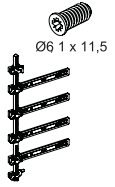

Smart Cevvelli Ray Montaj Şablonu

Smart-Bohrschablone mit Lineal

Rayların Vida Konum Ölçüleri
Schraubenposition der Schienenführungen

Rayı, koyu renk ile işaretlenmiş deliklerden vidalayınız.
Schauben Sie die Schiene an den markierten Löchern fest.

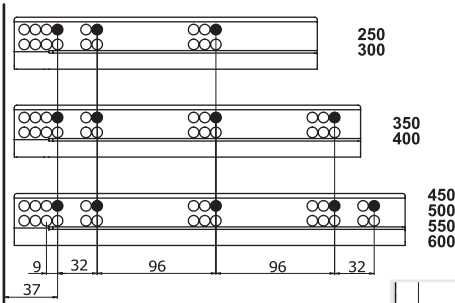

Bas - Aç Ayarı
Push-Open-Einstellung

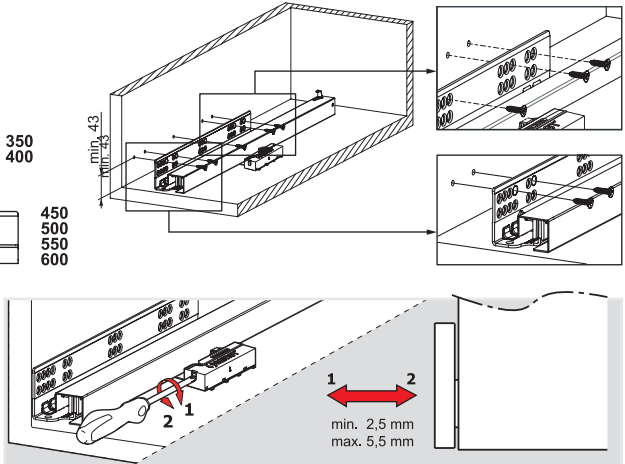

Çekmece Ölçüleri
Schubladenabmessungen

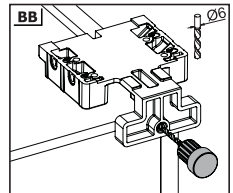
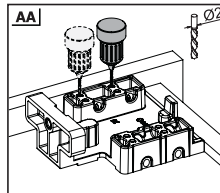
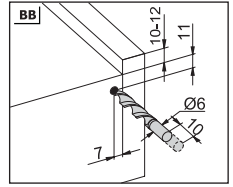
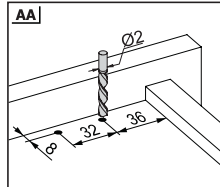
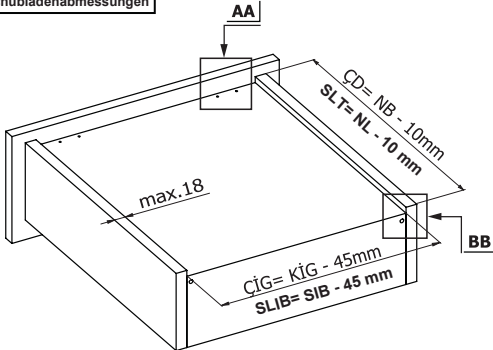

1

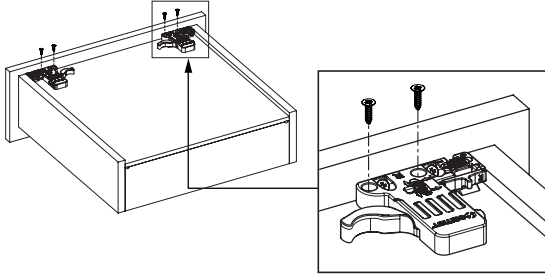

Not: Çekmece taban kalınlığı 12 mm'den küçük olduğunda, açılı mandal bağlama deliklerini kullanınız.

Hinweis: Verwenden Sie zur Montage von Smart Lock abgewinkelte Löcher, wenn die gewählte Holzbodenbreite weniger als 12 mm beträgt.

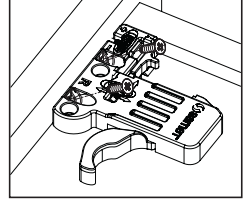
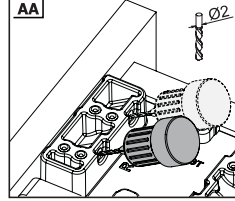

2

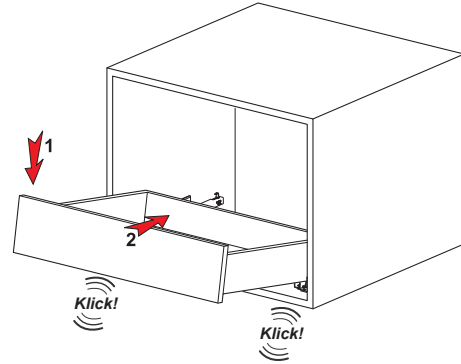

3

Somunu çevirerek, yukarıya doğru ayar yapabilirsiniz.
Die Aufwärtspositionierung lässt sich durch Drehen des Knopfes anpassen.

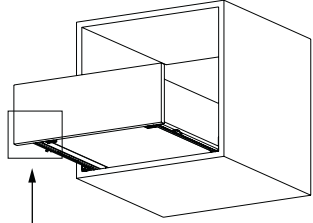
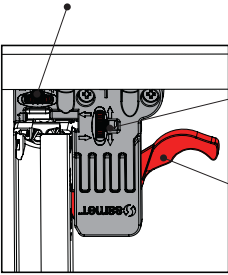

Somunu çevirerek, sağ-sol ayarını yapabilirsiniz.
Die Links-Rechts-Positionierung lässt sich durch Drehen des Knopfes anpassen.

Mandal kollarına aynı anda basarak, çekmeceyi kolayca yerinden çıkarabilirsiniz.
Sie können die Schublade leicht herausnehmen, indem Sie einfach den Drücker der Smart Lock-Arretierung betätigen.

Smart El Tipi Ray
Montaj Şablonu
Smart-Bohrschablone

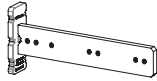

Kod / Code

12799902

12799904

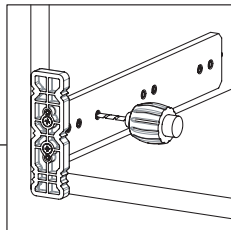
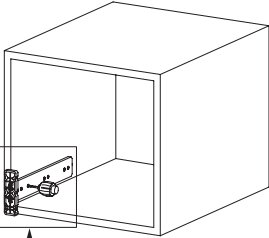

Smart Cetveli Ray
Montaj Şablonu
Smart-Bohrschablone mit Lineal

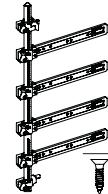

Kod / Code

12799901

12799905

